



User's Instructions

2065-03, 2025-03, 2026-03 Helmets



Copyright© Syntech International, Inc. All rights reserved.

For more Information:

U.S/ Canada/International

Telephone:

800-443-3842/ 949-752-9642

Fax:

949-752-9658

Website:

www.syntech-intl.com

E-mail:

info@syntechintl.com

Shipping/ Mailing Address:

Syntech International, Inc.
17171 Daimler Street
Irvine, CA 92614
USA

**** IMPORTANT - Please note WARRANTY AND TERMS AND CONDITIONS
regarding your MAXAIR Systems
by thoroughly reading the information on the MAXAIR Systems' Website ****

<http://www.maxair-systems.com >WARRANTY>



Syntech International, Inc. Disclaimer

NOTE

THE GOODS COVERED BY THIS CONTRACT HAVE BEEN PURCHASED BY THE BUYER "AS IS" AND "WITH ALL FAULTS," AND THE BUYER ACKNOWLEDGES THAT NO WARRANTIES OF MERCHANTABILITY OR FITNESS FOR ANY PARTICULAR PURPOSE ARE TO BE IMPLIED IN THIS TRANSACTION.

THIS SALE IS MADE ON THE EXPRESS UNDERSTANDING THAT THERE IS NO IMPLIED WARRANTY THAT THE GOODS SHALL BE MERCHANTABLE OR AN IMPLIED WARRANTY THAT THE GOODS SHALL BE FIT FOR ANY PARTICULAR PURPOSE. THE BUYER ACKNOWLEDGES THAT HE IS NOT RELYING ON THE SELLER'S SKILL OR JUDGMENT TO SELECT OR FURNISH GOODS SUITABLE FOR ANY PARTICULAR PURPOSE AND THAT THERE ARE NO WARRANTIES WHICH EXTEND BEYOND THE DESCRIPTION ON THE FACE HEREOF.

THE SELLER SHALL BE IN NO WAY RESPONSIBLE THE GOODS' PROPER USE AND SERVICE, AND THE BUYER HEREBY WAIVES ALL RIGHTS OF REFUSAL AND RETURN OF GOODS.

Any affirmation of fact or promise made by Seller shall not be deemed to create an express warranty that the goods shall conform to the affirmation or promise; any description of the goods is for the sole purpose of identifying them and shall not be deemed to create an express warranty that the goods shall conform to such description; any sample or model is for illustrative purposes only and shall not be deemed to create an express warranty that the goods shall conform to the sample or model; and no affirmation or promise, or description, or sample or model shall be deemed part of the basis of the bargain.

Syntech's exclusive distributor - Bio-Medical Devices International Inc. DBA MAXAIR Systems - has a warranty and return program that can be viewed online at: <https://maxair-systems.com/terms-and-conditions>.

Trademarks MAXAIR® and CAPR® are licensed to Syntech International, Inc.



Table Of Contents

1. Warnings, Cautions, Notes, and Symbols	6
1.1 Important Information	6
1.2 S- Special or Critical User's Instructions	7
1.3 SYMBOLS – General and Packaging	8
2. Regulatory and Marking Definitions	9
3. Introduction	10
3.1 Part Numbers, Order Numbers, Descriptions Reference	10
3.2 Systems and System Components	12
3.3 Head/Face Covers vs. Helmet/Battery Selections	13
3.4. Applicability of Earlier Version Components and Assemblies	14
3.4.1. Lithium-Ion Batteries (LIBS) - 2500-36TSC and 2500-30TSC	14
3.5 Helmets Overview	15
3.5.1 2065-03 Helmet - Common Helmet Characteristics except where noted	15
3.5.2 Helmet Differentiating Characteristics: 2025-03 and 2026-03	16
3.5.3 Characteristics Details (Refer to page 15)	17
3.6 Battery, Belt, and Charger Overview	19
4. Unpacking Standard System Components and Parts	20
Identification	20
4.1 Unpacking the 2065-03 Helmet	20
4.2 Unpacking the 2025-03 Helmet	21
4.3 Unpacking the 2026-03 Helmet	22
4.4 Unpacking the 2500-36TSC Battery	23
4.5 Unpacking the 2000-76 Battery Belt	24
4.6 Unpacking the 2600-01 Battery Charger	25
5. Instructions For Use: Common Components	26
5.1 Comfort Strips	26
5.2 Li-Ion Battery	27
5.3 Charger	28
6. Instructions For Use: Common Protocol	31
6.1 Inspections Before Use	31
6.2 Readyng the Helmet for Use	31
7. Instructions For Use	32
7.1 Hoods	32
7.1.1 Hood to Helmet Compatibility	32
7.1.2 2000-25DMA (01031301) and 2000-22A (01031303) with 2000-25 Pre-filter (01021084)	33
7.1.3 2120-10	36
7.1.4 2270-06	39
7.1.5 2272PB-07ML, 2272PB-07SM Hoods	44
7.2 Cuffs and Shrouds	48
8. Conversion to Dual Filter Shroud Configuration	52
9. Decontamination / Cleaning	55
10. General System Maintenance and Storage	56



11. Battery Use, Maintenance and Storage	58
11.1 Routine Infection Control use in med/surg and ED areas	58
11.2 Emergency Preparedness (EP) and In-Frequent Use	58
11.3 General Use, Maintenance, and Storage	59
11.3.1 Recommended Temperature Ranges	59
11.3.2 Use/Discharge	60
11.3.3 Charge	60
11.3.4 Store	60
11.3.5 Handling and Transport	60
11.3.6 Useful Life	61
11.3.7 LIB Check Procedure - MAXAIR LIB Test for Diminishing Battery Capacity	61
11.3.8 Reference Information	62
11.3.9 Glossary	62
11.3.10 Projected LIB Level Available As A % At Initial Manufacture Versus Temperature	63
12. Disposal	64
13. Accessories and Alternate/Replacement Parts	65
14. Specification	70

1. Warnings, Cautions, Notes, and Symbols

1.1 Important Information

The words WARNING, CAUTION, and NOTE have special meanings and should be reviewed.

WARNING	The personal safety of the user may be involved. Disregarding this information could result in injury to the user.
CAUTION	These instructions point out special procedures or precautions and must be followed. Disregarding this information could result in jeopardizing the product reliability.
NOTE	Provide special information that supplements and/ or clarifies important instructions.
	A triangle with an exclamation point alerts the intended user to place extra emphasis on reading and understanding the accompanying instructions for operating, maintenance and safety information.

Warnings and Cautions



WARNING

This User's Instructions and Instructions for Use, that accompany each package of system components, including the Warnings, Cautions and Special or Critical User's Instructions, must be read thoroughly and followed carefully by all persons who have, or will have, the responsibility for using the system. The system will perform as designed only if it is used and maintained per the User's Instructions. Failure to follow the User's Instructions may be hazardous to the user's health.



WARNING

NIOSH Cautions and Limitations

- A Not for use in atmospheres containing less than 19.5% oxygen, or more than 25% oxygen.
- B Not for use in atmospheres immediately dangerous to life or health.
- C Do not exceed maximum use concentrations established by regulatory standards.
- F Do not use powered air-purifying respirators if airflow is less than 4 CFM (115 LPM) for tight fitting face pieces or 6 CFM (170 LPM) for hoods and/or helmets.
- I Contains electrical parts that may cause an ignition in a flammable or explosive atmosphere.
- J Failure to properly use and maintain this product could result in injury or death.
- L Follow the manufacturer's instructions for changing cartridges, canisters and/or filters.
- M All approved respirators shall be selected, fitted, used, and maintained in accordance with MSHA, OSHA, and other applicable regulations.
- N Never substitute, modify, add, or omit parts. Use only exact replacement parts in the configuration as specified by the manufacturer.
- O Refer to User's Instructions, and/or maintenance manuals for information on use and maintenance of these respirators.
- P NIOSH does not evaluate respirators for use as surgical masks.
- S Special or Critical user's instructions and specific use limitations apply. Refer to User's Instructions before donning.

1.2 S- Special or Critical User's Instructions



WARNING

Special or Critical User's Instructions

- NIOSH approved HE filters can be used for protection against particulate aerosols containing oil. However, Bio-Medical Devices Intl does not recommend use of MAXAIR Systems in oily atmospheres unless specifically indicated on the product.
- Do not use near flame or other heat source.
- The use of MAXAIR Systems in an alarm condition is only for immediate exit to a safe environment.
- During high energy work (exertion) rates, it is possible to over-breathe the MAXAIR System and create a negative pressure situation.
- If air flow is cut off, immediately hold your breath and immediately exit to clean air.
- In the power-off state, little or no respiratory protection is to be expected. Attempted use in this manner is an abnormal situation.
- In the powered-off state, rapid buildup of carbon dioxide and depletion of oxygen within the MAXAIR system may occur.
- Non-Filtering areas of the Body Coverings for the 2270-06 Hoods are tested per ASTM F1671 by an accredited third party laboratory demonstrating compliance to the ANSI/AAMI PB70 Level 4 standard or testing criteria as applicable. NIOSH does not conduct this testing as part of their approval.



CAUTION

- When subjected to harsh use in critical environments (e.g. holding and dropping a battery by the power cord) the helmet-battery power cord will wear at a much faster rate than normal. In these types of circumstances, the power cord should be examined prior to each use, and it is recommended to be changed out every 30 days, or sooner if it becomes damaged or degraded.
- Do not operate in environments with temperatures exceeding 54°C
- A suitable environment is when an employee can work a full shift comfortably without any special paraphernalia other than normal clothing.
- Replace damaged or worn Filters immediately.
- Always start with a fully charged battery.
- Charge Li-Ion Batteries with MAXAIR Lithium-Ion battery chargers only.
- The Helmet Power Cord should not be removed from its connection to the Helmet unless the Power Cord needs replacement.
- Do not immerse system components in liquid.
- Never use compressed air to clean any part of the MAXAIR System.
- There are no user-serviceable parts inside the Helmet and Li-Ion Battery. Do not attempt to dis-assemble, open or service the Helmet and Li-Ion Battery. Call Customer Service, 1-800-443-3842, for assistance.

1.3 SYMBOLS – General and Packaging

1		European market “CE” and notified body number “0194”.	18		Catalog Number
2		National Institute for Occupational Safety and Health.	19		NIOSH Number
3		Refer to approval label and User’s instructions for cautions, limitations, and approved assembly configurations.	20		Batch Code
4		High Efficiency.	21		Quantity
5		Use By	22		Order Number
6		Material Fluid Resistance	23		Authorized representative in the European community.
7		Consult instructions for use (IFU)	24		Indoor Use Only
8		Consult User Instructional Manual (UIM) of MAXAIR System	25		Type L and Type R Listing Marks for Canada and the United States
9		Do Not in environments requiring intrinsic safety	26		UL Recognized Component Marks for Canada and the United States.
10		Place of Manufacture	27		European EMC testing to EN60601-1
11		Date of Manufacture	28		Caution, risk of electrical shock. High Voltage.
12		Storage Kept Dry. Keep away from rain.	29		Double insulation
13		Storage Humidity Upper limitation.	30		Recyclable.
14		Storage Temperature limitation.	31		Caution, Warning
15		Battery: Operational Upper limit of temperature.	32		British Standard: Respiratory protective devices- Powered filtering devices incorporating a helmet or a hood.
16		Per Directive 2002/96/EC, product must be collected separately. Do not dispose of as unsorted municipal waste. Contact local distributor for disposal information.	33		Charging
17		Per Directive 2006/66/EC, collect and recycle batteries/ battery packs according to EU Member State regulations.	34		Charge Complete.

2. Regulatory and Marking Definitions

All MAXAIR Systems based on the 2065-03, 2025-03, and 2026-03 Helmets, including pre-filters, filters, and head/face covers are NIOSH approved.

Refer to the official regulatory approval inserts and the following NIOSH website addresses for official MAXAIR Systems regulatory approval status.

http://www2a.cdc.gov/drds/cel/cel_results.asp?startrecord=1&Search=cel_form&maxrecords=50&manufacturer=BMD&appdatefrom=&appdate to=&powered=&scbatype=&scbause=&privatelabel=

http://www.cdc.gov/niosh/npptl/topics/respirators/disp_part/PAPRtables.html

Filter markings and colors contain unique information respective to NIOSH.

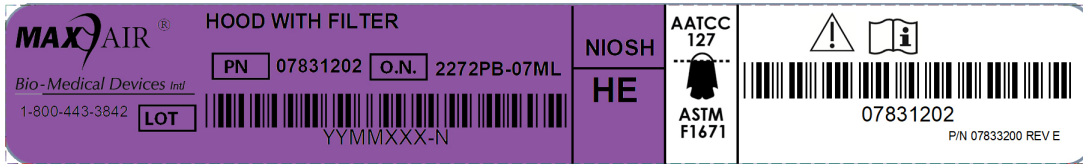

NOTE

Artwork Shown is for Reference Only based on example of 2272PB-07 Hood.

NIOSH (Contents within magenta background): MAXAIR Systems provide HE- High Efficiency Particulate Air Filtering per NIOSH 42 CFR 84.

- "HE" and "NIOSH" are specific terminology for Filter Protection Classifications per NIOSH VFR.
- Purple label background color is specific to NIOSH Filter color coding requirement per ANSI Z88.7-2001.



CAUTION

The purchaser/user is responsible for determining the appropriateness of the MAXAIR System for each/any of their particular applications/environments.

3. Introduction

3.1 Part Numbers, Order Numbers, Descriptions Reference

P/N *	REF *	DESCRIPTION
02531219 2590-01	2065-03	UNIVERSAL SINGLE POST HELMET WITH CAGE PKG.
02531222 2590-01	2025-03	TRI-SNAP HELMET
02531222 02531250 2590-01	2026-03	2025-03 Helmet with ChinBar
2590-01	2590-01	POWER CORD
2590-03	2590-03	POWER CORD W/ QUICK CONNECT
	2099-01	2065-03 to 2025-03 Conversion Kit
02531250	2099-02	Chin Bar for 2025-03 Helmet
07631022	2367-02	QUICK CUFF
07831038	2270-06SM	L4 HE Hood for 2076-03/2026-03 Helmet, Small Medium
07831039	2270-06ML	L4 HE Hood for 2076-03/2026-03 Helmet, Medium Large
07831040	2170-26	Heavy Loading Filter (HLF)
01031301	2000-25DMA	MEDICAL FILTER/HOOD
01031303	2000-22A	HOOD, NON-OILY DUST, MELTBLOWN WITH NO RETAINING PRONGS
01021084	2000-25D	PRE FILTER, DISPOSABLE MAXAIR
01031027	2120-10	HE FILTER DOUBLE SHROUD
07831202	2272PB-07ML	XP DOUBLE SHROUD HOOD
07831173	2272PB-07SM	XP DOUBLE SHROUD HOOD
01021609	2061-05	HIGH FLUID RESISTANCE FILTER COVER CAP (HFR FCC)
01031254	2165-10	POST FILTER CARTRIDGE
01031148	2061-01	FILTER COVER
01031186	2260-01	DISPOSABLE SHROUD, SM/MED
01031217	2260-02	DISPOSABLE SHROUD, MED/LG
01031151	2360-01	DISPOSABLE CUFF, SM/MED
01031220	2360-02	DISPOSABLE CUFF, MED/LG
01532104	2500-36TSC	LITHIUM ION BATTERY (4-8 HRS), SECURED CORD
01532116	2500-30TSC	LITHIUM ION BATTERY (8- 10 HRS), SECURED CORD
01532161	2500-37TSC	LITHIUM ION BATTERY (6-9 HRS) SECURED CORD
2000-76	2000-76	LITHIUM-ION BATTERY BELT

* REF numbers shown without parantheses, P/N shown within parantheses throughout the descriptive text.

P/N	REF	DESCRIPTION
01432089	2600-01	"CELL-CON" SINGLE CHARGER, LITHIUM ION BATTERY
	2601-06	CE/UL 6-GANG CHARGER
	2601-06B	CE/UL 6-GANG CHARGER BRACKET
01432202	2600-02	SINGLE CHARGER
02531132	2000-203	CHIN STRAP
02521215	02521215	UIM for 2065-03 Helmet Based* Systems (02521215)

***Using 2065-03 as the base for 2065-03, 2025-03, 2026-03, et al Helmet Configurations.**

3.2 Systems and System Components

Systems are configured from a base of four main components, a Helmet, a Battery, a Battery Belt, and a Battery Charger. The Belt is common to all systems.

The Helmet and Battery determine the available Head/Face Covers available to a specific System

ITEM	REF	DESCRIPTION
78SP-36		
1	2065-03	Helmet
2	2500-36TSC	Li-Ion Battery
3	2000-76	Li-Ion Battery Charger
4	2600-01*	Battery Belt
78SP-30		
1	2065-03	Helmet
2	2500-30TSC	Li-Ion Battery
3	2000-76	Li-Ion Battery Charger
4	2600-01*	Battery Belt
300TS-36		
1	2025-03	Helmet
2	2500-36TSC	Li-Ion Battery
3	2600-76	Li-Ion Battery Charger
4	2600-01*	Battery Belt
300TS-30		
1	2025-03	Helmet
2	2500-30SC	Li-Ion Battery
3	26000-76	Li-Ion Battery Charger
4	2600-01*	Battery Belt
326TS-36		
1	2026-03	Helmet
2	2500-36TSC	Li-Ion Battery
3	2000-76	Li-Ion Battery Charger
4	2600-01*	Battery Belt
326TS-30		
1	2026-03	Helmet
2	2500-30TSC	Li-Ion Battery
3	2000-76	Li-Ion Battery Charger
4	2600-01*	Battery Belt

* The alternate 2600-02 Single Charger may be substituted in place of the 2600-01.



3.3 Head/Face Covers vs. Helmet/Battery Selections

The Table demonstrates which system component and which Head and Face Cover is compatible with which Helmet and Battery combination.

HELMET (REF)		2065-03		2025-03		2026-03		
BATTERY (REF)		2500 -36TSC	2500 -30TSC	2500 -36TSC	2500 -30TSC	2500 -36TSC	2500 -30TSC	2500 -37TSC
REF	DESCRIPTION	APPLICABILITY						
2000-76	Battery Belt	✓	✓	✓	✓	✓	✓	✓
2600-01	Battery Charger, Single	✓	✓	✓	✓	✓	✓	✓
Hoods and related								
2000-25DMA	HE Filter Hood	✓	✓					
2000-22A	Hood	✓	✓					
2000-25D	Prefilter	✓	✓					
2120-10	Double Shroud Hood				✓			
2270-06	HE Hood					✓	✓	
2272PB-07ML	XP Double Shroud Hood			✓	✓	✓		
2272PB-07SM	XP Double Shroud Hood			✓	✓	✓		
2061-05	HFR FCC			✓	✓	✓		
Shrouds & Cuffs and related								
2061-01	Filter Cover	✓	✓					
2160-10	Filter	✓	✓					
2260-01	Disposable Shroud, Medium Large	✓	✓					
2260-02	Disposable Shroud, Medium Large	✓	✓					
2360-01	Disposable Cuff	✓	✓					
2360-02	Disposable Cuff	✓	✓					
Specialty Configuration								
2165-10	Filter Cartridge		✓					
Helmet Options								
2590-01	Straight Power Cord, 59"	✓	✓	✓	✓	✓	✓	✓
2590-03	Straight Power Core, 59", Quick Connect	✓	✓	✓	✓	✓	✓	
2000-203	Chin Strap							
Options for Charging								
2601-06	6-Gang Charger, w/ 2600-01 Chargers	✓	✓	✓	✓	✓	✓	
2601-06B	6-Gang Charger Bracket, for 2600-01 Chargers	✓	✓	✓	✓	✓	✓	

3.4. Applicability of Earlier Version Components and Assemblies

3.4.1. Lithium-Ion Batteries (LIBS) - 2500-36TSC and 2500-30TSC

The 2500-36TSC (01532104) supersedes the 2000-36 and 2000-36T LIBs (01531032).

The 2500-30TSC (01532116) supersedes the 2000-30 and 2000-30T LIBs (01531030).

The functionality and performance of the 2500 Series LIBs is equivalent to those LIBs they supersede and they may be used interchangeably relative to performance and application.



CAUTION

The power cord for the 2500 Series LIBs has a different cord-to-battery connector (A) and this cord must be used with the 2500 Series LIBs, and not the older cord (B). The new cord is also compatible with the older style LIBs. The older cords do not connect reliably with the 2500 Series LIBs and must not be used with these new LIBs.

When you purchase a 2500 Series LIB you will receive new power cords for each of the MAXAIR Helmets you have purchased over time. You must discard all older power cords when you receive your new 2500 Series LIBs to ensure you are always using the correct connector, regardless of newer or older battery.

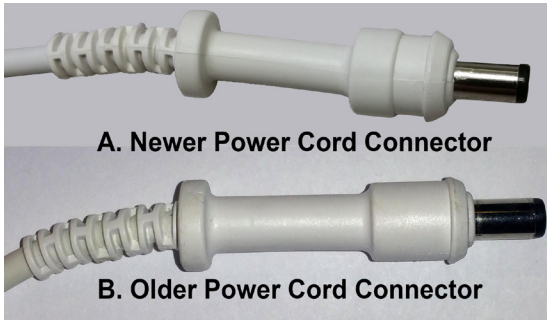

To Exchange Power Cords



1. Firmly grasp the flat sides of the older Power Cord-to-Helmet Connector.



2. Firmly lift the flat Power Cord-to-Helmet Connector up and out of the Helmet receptacle.

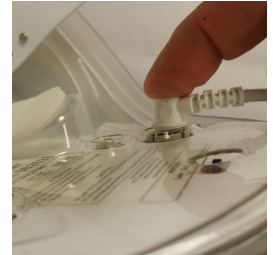

3. Place the newer Power Cord-to-Helmet Connector into the Helmet receptacle and push in until it is firmly seated.



NOTE

The 2500 Series LIBs incorporate a Secure Lock Button and mechanism that securely locks the power cord connector, from the helmet, into the battery connector. The operation of this Secure Lock Button is described in all appropriate sections of the User's Instructions.



Please contact Customer Service at info@maxair-systems.com, or 1-800-443-3842, if you need more information.

3.5 Helmets Overview

3.5.1 2065-03 Helmet - Common Helmet Characteristics except where noted

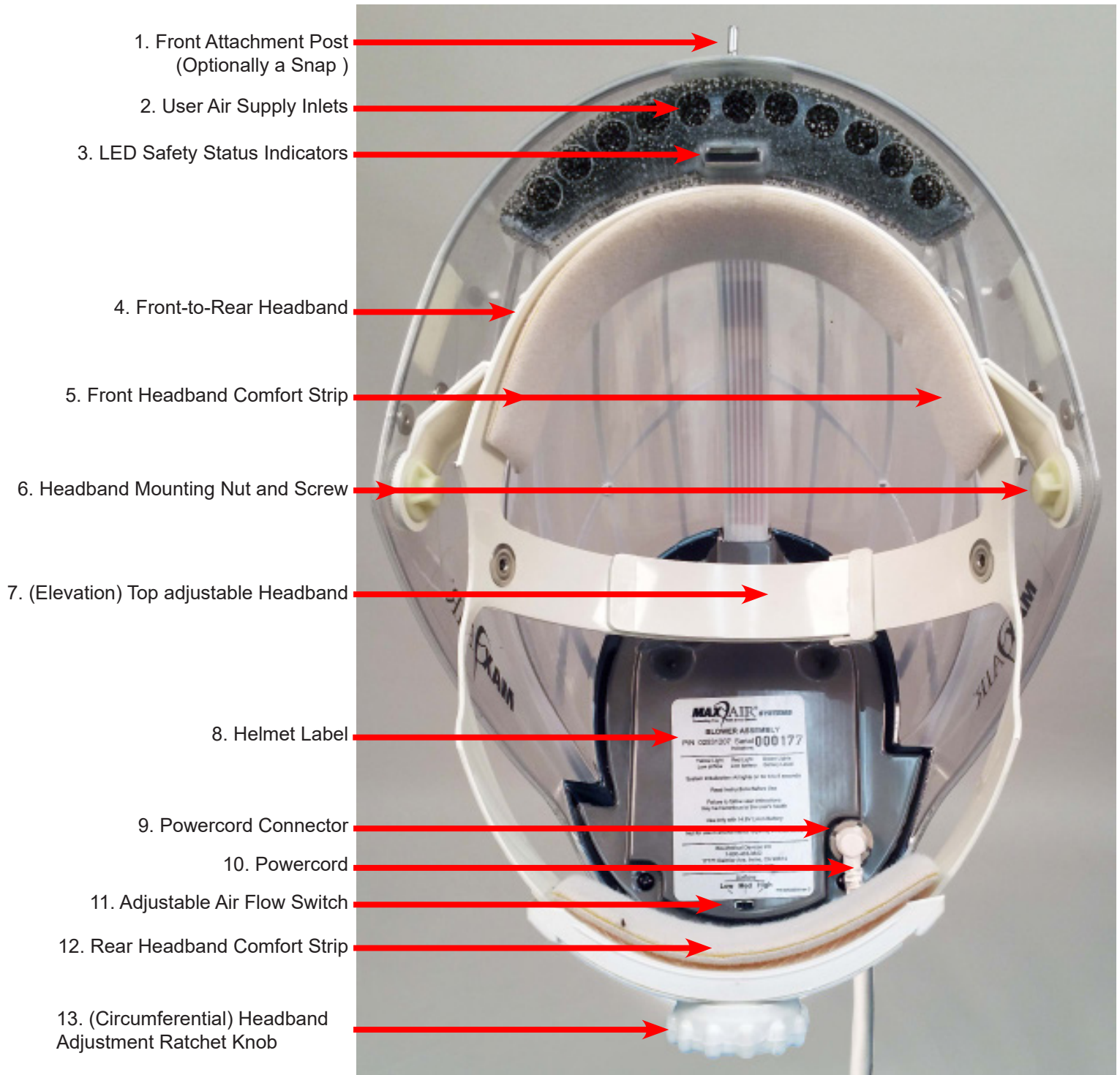

3.5.2 Helmet Differentiating Characteristics: 2025-03 and 2026-03

The 2025-03 and 2026-03 Helmets are variations from the 2065-03 Helmet with the following differentiations.

REF. 2065-03
P/N 02531219
Single Post

REF 2025-03
P/N 02531203, 01031269
Tri-Snap w/Filter Frame
(Front Snap vs. Single Post)

REF 2026-03
2025-03 Helmet with ChinBar*
02531203
01031269
02531250
2590-01
Tri-Snap w/Filter Frame and ChinBar

*ChinBar is optional with
2272PB-07 ML&SM Hoods

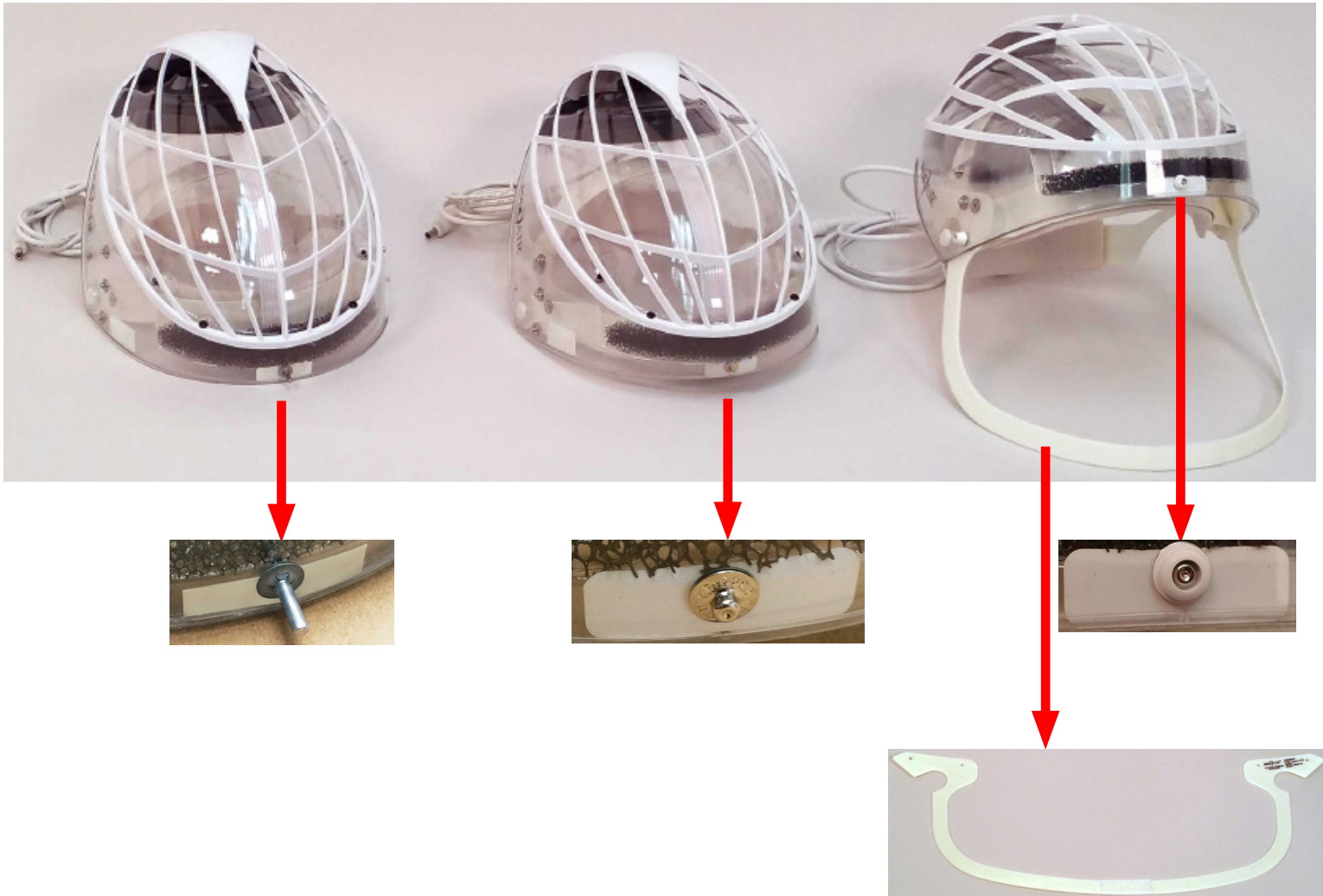

3.5.3 Characteristics Details (Refer to page 15)

1 Front Attachment Post (Snap on 2025-03 and 2026-03 Helmets)

Facilitates placement of Helmet Covers and Hoods.

2 User Air Supply Inlets

Filtered incoming air for breathing, cooling comfort, and to maintain fog free lens.

3 LED Safety Status Indicators



WARNING

Failure to heed the LED Safety Status Indicators and exit immediately to a safe environment when alarm conditions are present may be hazardous to the user's health. When Green LEDs are not lighted, the user should immediately exit to a safe area to obtain a recharged Battery.

- The Helmet has five LED Safety Status Indicators located on its underside front that are always visible in the user's peripheral vision. They alert the user to the safe operating conditions of the system. They will provide an early warning alert to the user when the Helmet is no longer able to maintain adequate airflow and/or Battery charge to provide adequate or continuing protection for the user.
- There are five LED Safety Status Indicators, one yellow, three green, and one red. On start-up, all LED's should come on briefly (LED test) before proceeding to normal operation. During normal operation, the LEDs continuously indicate the status of the Airflow and Battery charge level.
- Airflow is proper if the Yellow LED is off. A continuously lit or flickering Yellow LED indicates low or marginal airflow. If the Yellow LED is lit, check the Filter Cartridge for excess particulate/dirt build-up and damage, and replace if necessary.
- The Battery charge level is indicated by the three Green and one Red LEDs. The approximate charge level is continuously indicated by the changing LEDs.

CONDITION	DESCRIPTION	YELLOW	GREEN 3	GREEN 2	GREEN 1	RED
1	Battery charge OK, 75% to 100%, Airflow OK		✓	✓	✓	
2	Battery charge OK, 50% to 75%, Airflow OK			✓	✓	
3	Battery charge OK, 25% to 50%, Airflow OK				✓	
4	Battery charge LOW, 0% to 25%, Airflow OK					✓
5	Airflow LOW, Battery charge LOW	✓				✓
6	Airflow LOW, Battery charge OK, 75% to 100%	✓	✓	✓	✓	
7	Airflow LOW, Battery charge OK, 50% to 75%	✓		✓	✓	
8	Airflow LOW, Battery charge OK, 0% to 50%	✓			✓	

- When all three Green LEDs are lit, the Battery has approximately 75% to 100% of its charge.
- When two Green LEDs are lit, the Battery has approximately 50% to 75% of its charge.
- When only one Green LED is lit, the Battery has approximately 25% to 50% of its charge. When this occurs the user should prepare to exit to a safe area to obtain a fully charged Battery.
- When all three Green LEDs are off and the Red LED is lit, the Battery level is low, with approximately 0% to 25% charge left. When this occurs the user should promptly exit to a safe area to obtain a fully charged Battery.
- If the Battery did not provide 8-10 hours of use, change to a fully charged Battery or recharge the current Battery. (The optional large Battery can provide as much as 16-20 hours of use per charge).

4 Front-to-Rear Headband

Front and Rear (continuous loop) Headband allows user comfort adjustment for headsize circumference differences.

5 Front Headband Comfort Strip

Provides user comfort for long term use and tightening Headband for a secure hold during all activities.

6 Headband Mounting Nut and Screw

Secures Headband to Helmet.

7 (Elevation) Top adjustable Headband

Additional adjustment for different size heads and to assist proper positioning to see LED Status Indicators easily in the upper peripheral vision.

8 Helmet Label

P/N, REF and SN identification. Refer to symbol definition chart for further details.

9 Helmet Power Cord Connector

Connection for the Power Cord to the Helmet, which then connects to the Battery. The Power Cord should not be disconnected from this connector under normal operation conditions.

10 Power Cord

Battery to Helmet Connection. For replacement, refer to Section 10.

11 Adjustable Airflow Switch (Air Flow Controller)**CAUTION**

The Air Flow Switch is user adjustable to match the amount of air flow with the user's activity level and breathing requirements.

Helmets are equipped with a switch which adjusts the operating airflow. When the Helmet is first turned on it will start at a low level, then the airflow will increase to a preset point according to the switch position.

**NOTE**

When the Helmet is initially connected to the Battery, all five LED Safety Status Indicators are lighted briefly indicating all are functional. The red and yellow LEDs will turn off and the airflow increases to the appropriate operating level based on the Air Flow Switch position. The green LEDs will be on as appropriate to the battery charge level as indicated in the LED Safety Status Indicators table (previous page).

Air Flow Switch Position		
Low	Med	High
Air Flow in Liters Per Minute		
190	215	240

**NOTE**

The flow levels, in liters per minute, are only approximate.

12 Rear Headband Comfort Strip

Provides cushion for comfort and sizing for very small head sizes. Attached via Hook and Loop, and removable. For replacement, refer to Section 5.1.

13 (Circumferential) Headband Adjustment Ratchet Knob

Head circumference adjustment knob.

3.6 Battery, Belt, and Charger Overview

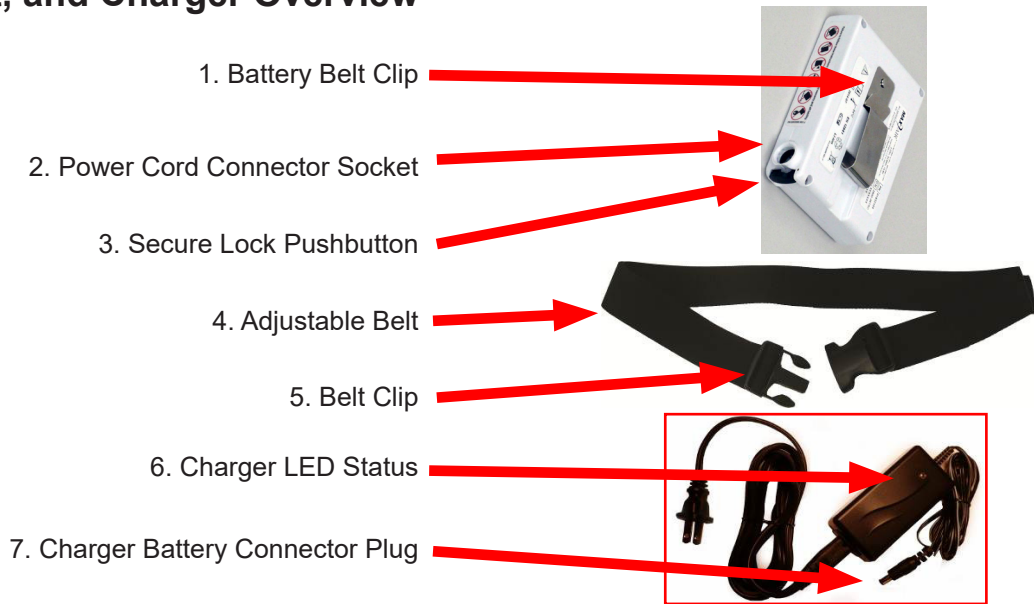

#	Characteristics
1	Attaches to Adjustable Belt or clothing
2	Socket for Helmet's Power Cord or Charger's Battery Plug.
3	Releases the Power Cord Connector for removal
4	Wraps around waist. Battery is attached to belt via the belt clip.
5	Secures belt to the waist.
6	Charging status indicator for Li-Ion Battery. Red= Charging Green= Charge Complete
7	Plugs into Li-Ion Battery socket.

Battery and Charger Symbol Definitions

These symbols are located on the devices and are defined as follows

Battery

	Rechargeable. For use only with MAXAIR Li-Ion Batteries		Do not attempt to dis-assemble, open, or service.
	Do not place near or in a flame.		Do not drop.
	Do not immerse in liquid.		Do not puncture.

Charger

	Charger's Green LED light, Charge Completed.		Charger's Red LED light, Charging
--	---	--	--------------------------------------

4. Unpacking Standard System Components and Parts Identification

4.1 Unpacking the 2065-03 Helmet

Carefully unpack the 2065-03 MAXAIR Helmet from the shipping box. Verify there are no missing or loose components and that the helmet shows no signs of physical damage. Assemble the Helmet into the desired configuration and verify that it is fully functional. Report any damage to the shipper immediately for resolution.

Contact Customer service 1-800-443-3842, if you have questions.

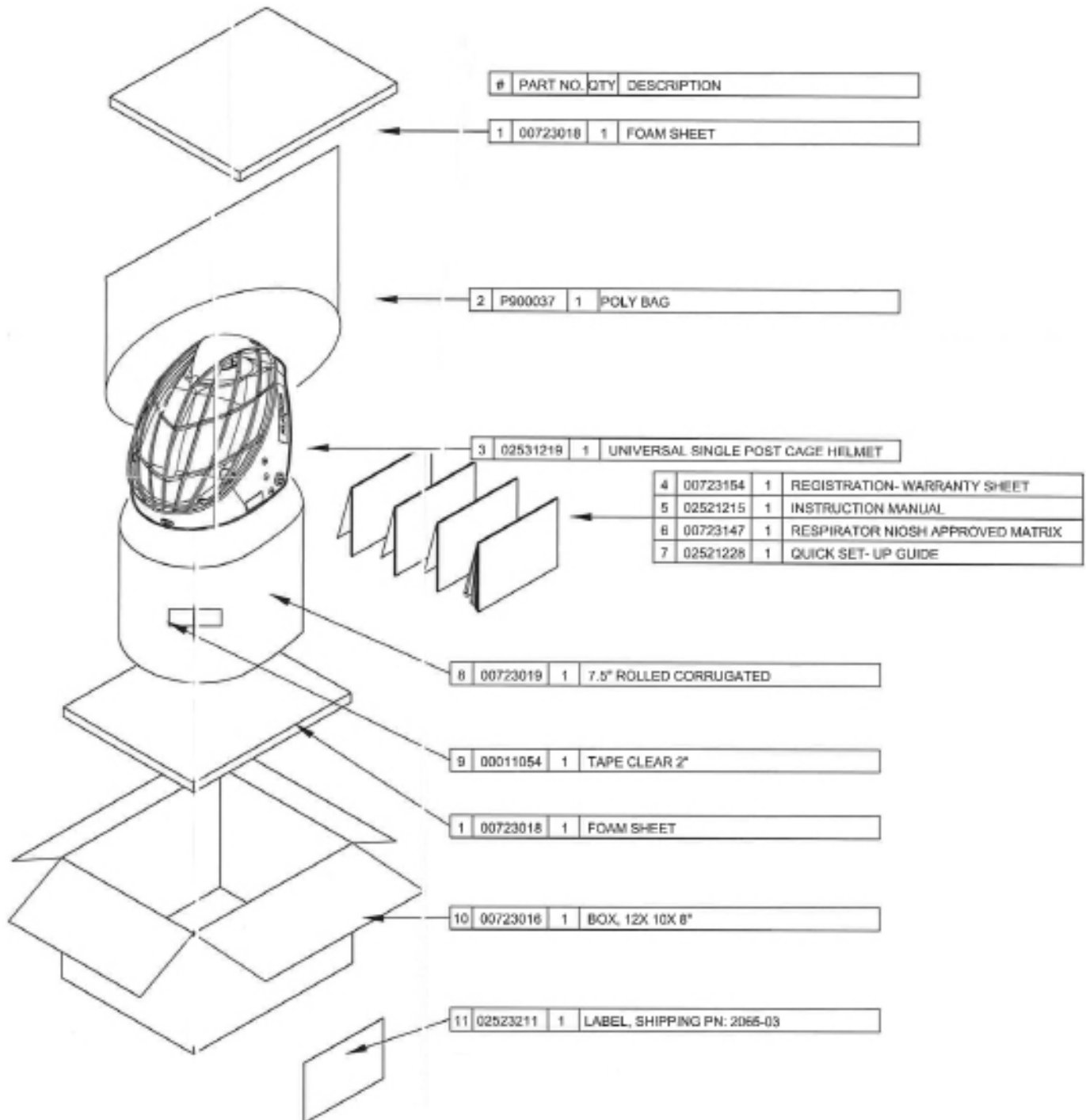

4.2 Unpacking the 2025-03 Helmet

Carefully unpack the 2065-03 MAXAIR Helmet from the shipping box. Verify there are no missing or loose components and that the helmet shows no signs of physical damage. Assemble the Helmet into the desired configuration and verify that it is fully functional. Report any damage to the shipper immediately for resolution.

Contact Customer service 1-800-443-3842, if you have questions.

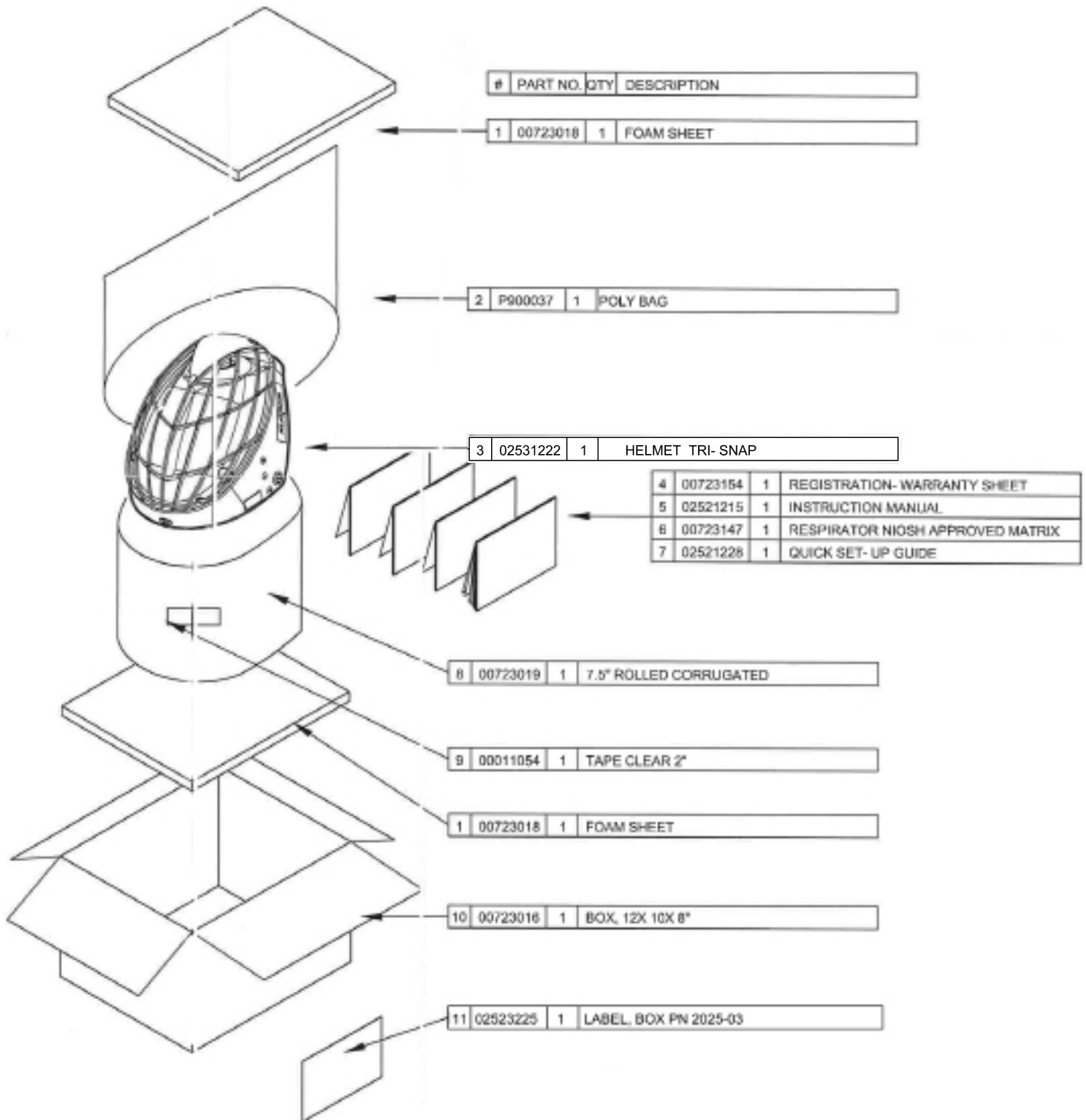

4.3 Unpacking the 2026-03 Helmet

Carefully unpack the 2065-03 MAXAIR Helmet from the shipping box. Verify there are no missing or loose components and that the helmet shows no signs of physical damage. Assemble the Helmet into the desired configuration and verify that it is fully functional. Report any damage to the shipper immediately for resolution.

Contact Customer service 1-800-443-3842, if you have questions.

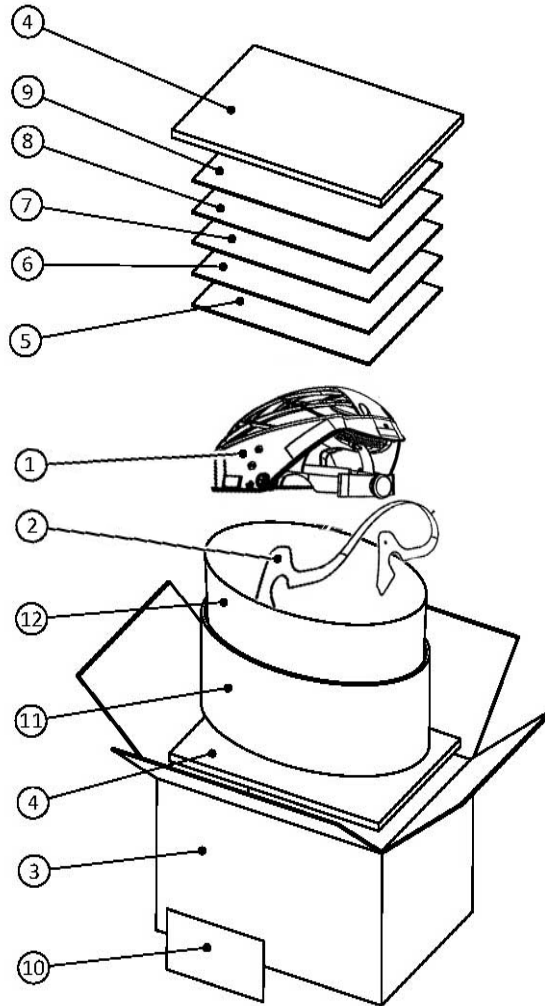

Item#	Part Number	Description
1	02531222	Universal Tri-Snap Cage Helmet
2	02531250	Chin Bar
3	00723016	Box 12 x 10 x 8
4	00723018	Foam Sheet
5	00723147	Approval Label, Respirator
6	00723154	Registration - Warranty Sheet
7	02521228	Quick Set-up Guide
8	02521215	Instruction Manual
9	03521080	Symbol Definition Chart
10	02523251	Label, Box P/N 2026-03
11	00723019	8" x 250' Single Face Rolled Corrugated
12	P900037	Bag, 18 x 24 x 0.002
13	33-003-001	Twist Tie, 4"

4.4 Unpacking the 2500-36TSC Battery

Carefully unpack the 2500-36TSC Battery from the shipping box. Verify there are no missing or loose components and that the Battery show no signs of physical damage. Connect the Battery to a fully assembled CAPR Helmet with Filter Cartridge and Filter Cover Cap or Hood to verify that it powers the Helmet and that at least one Green LED lights. Report any damage or non-function to the shipper immediately for resolution. (Instructions are similar for all MAXAIR Systems batteries.)

Contact Customer service 1-800-443-3842, if you have questions.

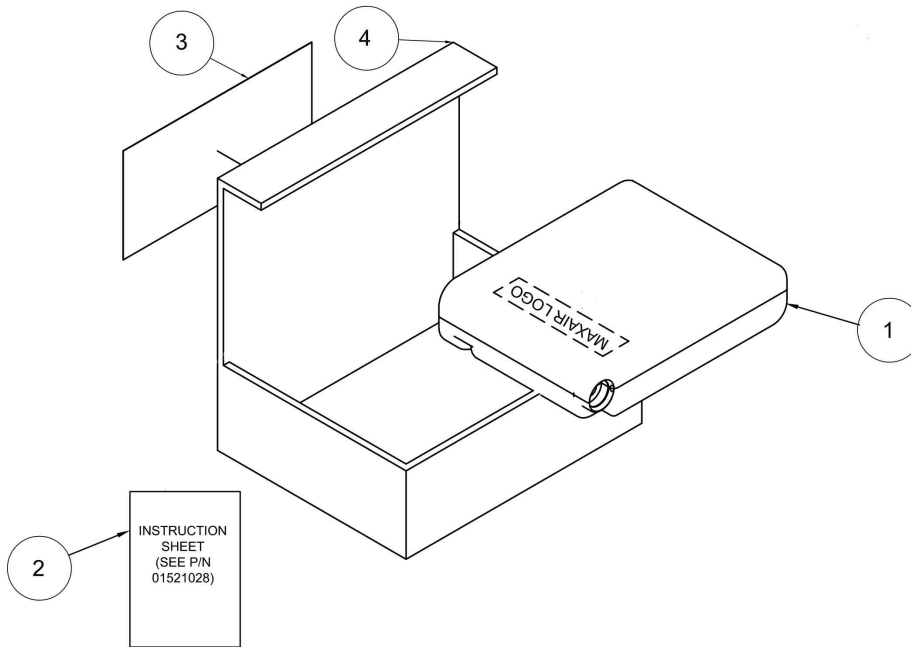

ITEM	QTY	PART NUMBER	DESCRIPTION
1	1	01532104	LI-ION BATTERY
2	1	01523128	INSTRUCTION SHEET
3	1	01523115	BOX LABEL
4	1	P900127	BOX

4.5 Unpacking the 2000-76 Battery Belt

Carefully unpack the 2000-76 Battery Belt from the shipping bag. Verify there are no missing or loose components and that the Belt shows no signs of physical damage. Report any damage or non-function to the shipper immediately for resolution.

Contact Customer service 1-800-443-3842, if you have questions.

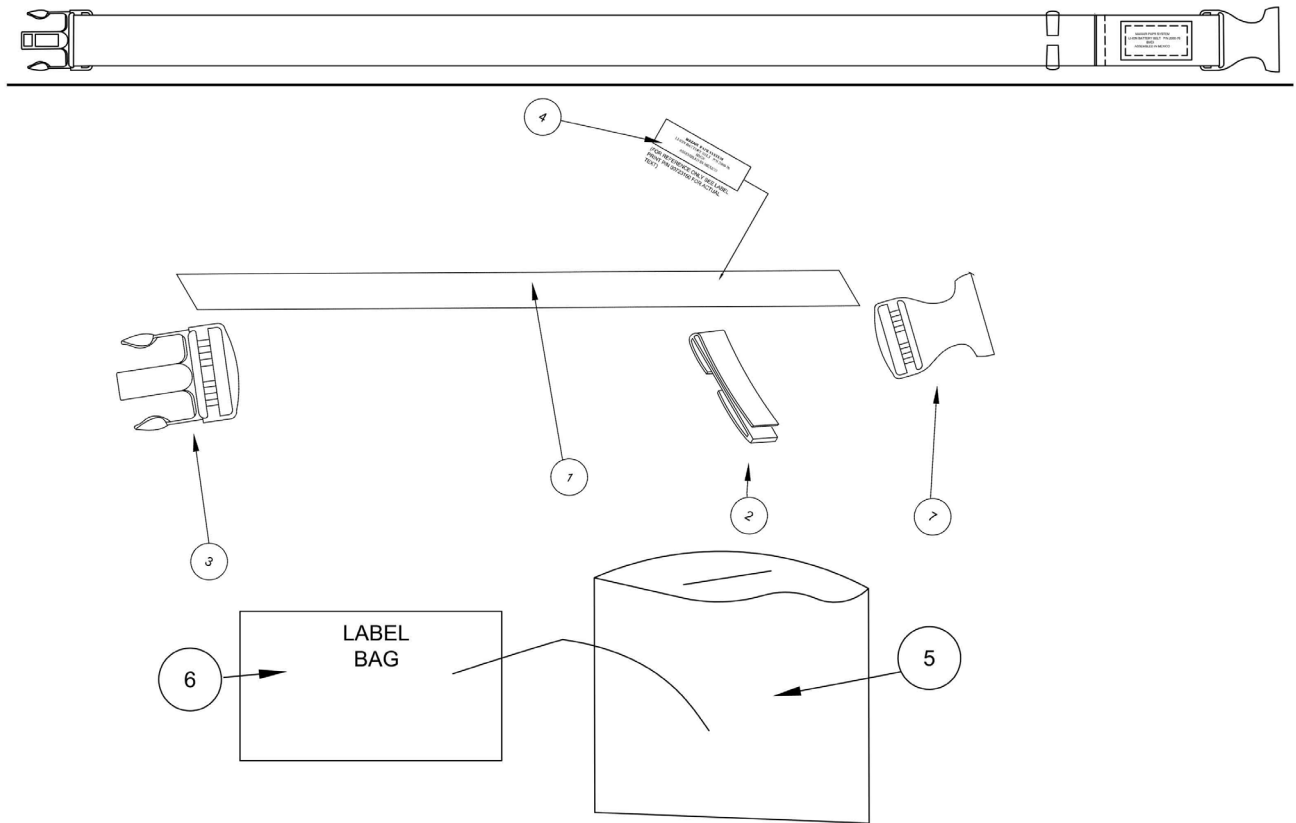

7	1	DUAL BODY	00721160
6	1	LABEL, BAG LITHIUM-ION BELT	00723151
5	1	BAG SWEATBAND 12 X 16	P900263
4	1	LABEL PART NUMBER	00723150
3	1	BELT CLIP	00721143
2	1	BELT HOLDER	00721144
1	1	PLASTIC WEBBING	P940003
ITEM	QTY	DESCRIPTION	PART NUMBER

4.6 Unpacking the 2600-01 Battery Charger

Carefully unpack the 2600-01 Battery Charger from the shipping box. Verify there are no missing or loose components and that the Charger shows no signs of physical damage. Connect the Charger to a working wall outlet and verify that the Green LED is lit. Connect the Charger to a Battery that powers a MAXAIR Helmet with either a red LED or one or two Green LEDs lit, and verify that when that Battery is connected to the Charger, the Charger LED turns from Green to Red to indicate that it is charging the Battery. Report any damage or non-function to the shipper immediately for resolution. (Follow similar procedure for alternate MAXAIR Chargers.)

Contact Customer service 1-800-443-3842, if you have questions.

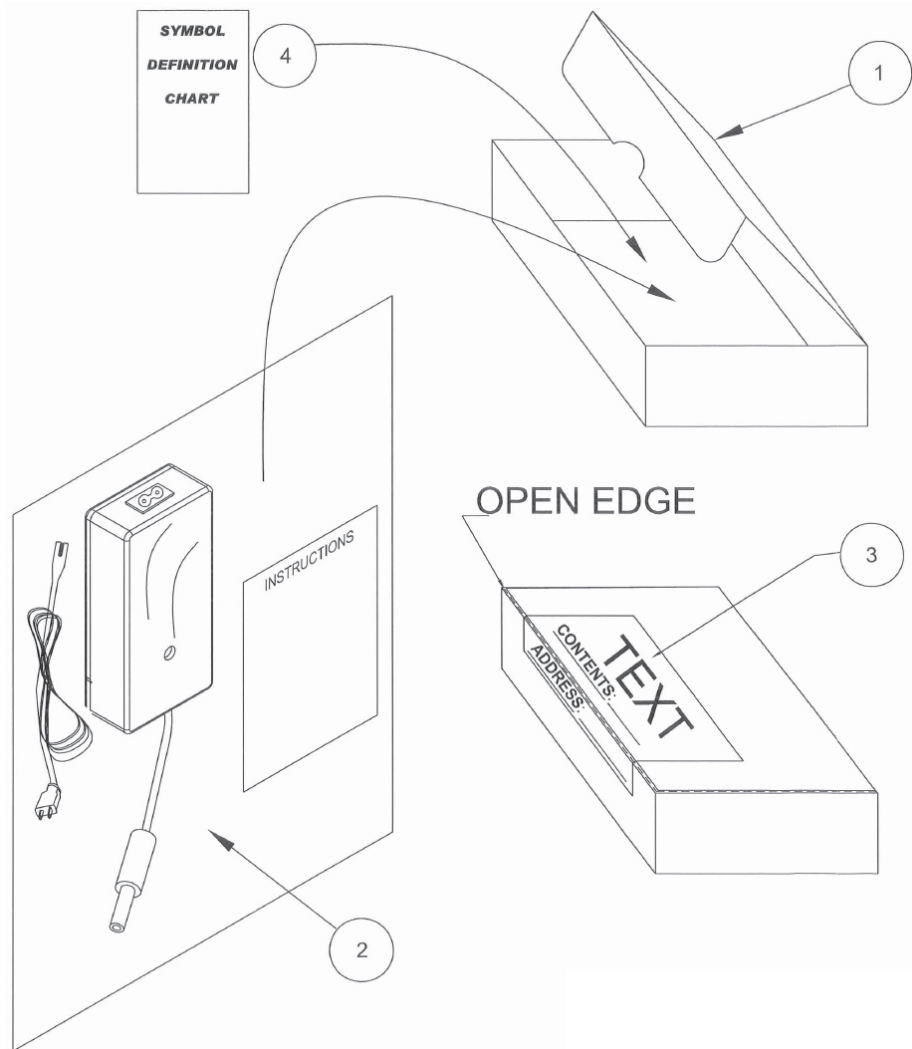

4	1	03521080	SYMBOL DEFINITION CHART
3	1	01433093	SHIPPING LABEL
2	1	01432089	ASSY. BATTERY CHARGER, li-Ion , SINGLE
1	1	P900127	BOX, SHIPPING
Item	Qty.	Part Number	Description

5. Instructions For Use: Common Components

5.1 Comfort Strips

Comfort Strips: REF 2000-201; P/N P900072

Assembly and Disassembly: Comfort Strips

**NOTE**

Only one side of the comfort strip will attach to the hook tape on the Headband.

1. To remove a damaged or soiled Comfort Strip, pull it away and off of the Headband.
2. To attach a new Comfort Strip, align it parallel to the Headband with the loop side facing the Headband and press it on.

**NOTE**

The Rear Headband Comfort Strip is made by cutting a Comfort Strip in half.

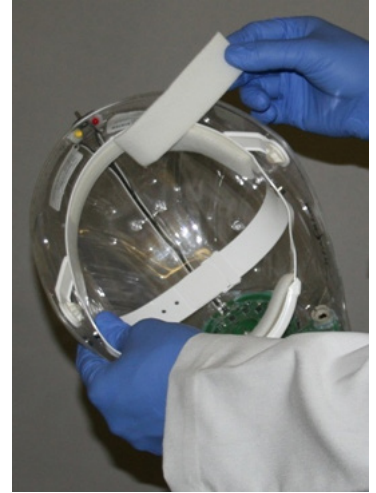

MAXAIR®

5.2 Li-Ion Battery

	REF	P/N
BATTERY, LITHIUM ION , LARGE	2000-30T	01531030
BATTERY, LITHIUM ION , SMALL	2000-36T	01531032
LITHIUM ION BATTERY (8- 10 HRS), SECURED CORD	2500-30TSC	01532116
LITHIUM ION BATTERY (4-8 HRS), SECURED CORD	2500-36TSC	01532104

The Li-Ion Batteries, 2000-36TSC and 2000-30TSC, are components of the MAXAIR CAPR Line of Powered Air Purifying Respirators.



CAUTION

Inspect the Battery for damage before every use. Do not use if damaged.
 Always start with a fully charged Battery and use with the MAXAIR System only.
 Fully recharge Batteries immediately after every use.
 Charge the Battery only with a MAXAIR Lithium Ion Charger. See the Charger's Instructions for use.
 If the Charger LED is red when the Battery is connected, the Battery is not fully charged.
 If it is necessary to use a non-fully charged Battery, precede using extreme CAUTION. Take very careful note of the Helmet LED Safety Status Indicators when the Battery is connected to the Helmet Power Cord. Refer to the Helmet LED Safety Status Indicator LED Matrix table in Section 5.2, as well as the information in Section 12. to estimate the amount of useful time remaining on the Battery if it is not in a fully charged condition. Proceed once it is determined that there is sufficient charge in the Battery for the next activity.

Securing the Battery

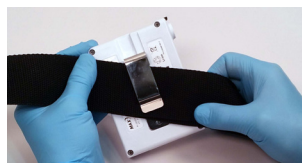

1. Obtain a fully charged battery. (Charger LED should be green after battery is connected to charger for more than 10 seconds.)
2. Assemble the battery onto the belt. Place the top edge of the Belt under the Battery Clip. Move the Belt fully under and up to the top of the Clip.
3. Place the belt comfortably around the waist with the battery near the side-back of the right hip.



CAUTION

Ensure the power cord connector is fully secured into the battery connector socket. Push the cord connector all the way in until the battery connector socket stops further inward movement of the power cord connector. Handle the power cord by the connector, not the cord.

Connecting the Battery to the Helmet



To initiate air-flow, connect the Helmet Power Cord to the Battery. Push the Power Cord Connector into the Battery Receptacle until the Secure Connection audibly clicks.

Disconnecting the Battery from the Helmet

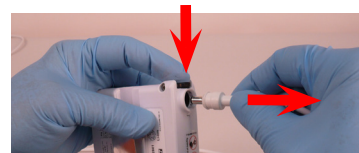

Disconnect the Helmet Power Cord from the Battery - push the Secure Connection Button down, pull Cord Connector out, release the Button.

Material safety data sheet (MSDS) available upon request.

5.3 Charger

Charger: REF 2600-01; P/N 01432089 and alternate, REF 2600-02; P/N 01432202.

The 2600-01 Charger is a component of the MAXAIR Line of Powered Air Purifying Respirators.

CAUTION

Inspect the charger for damage before every use. Do not use if damage is apparent or suspect. A battery should be connected to a charger only until the Charger LED turns Green indicating a fully charged Battery. When the Charger LED turns Green, the Battery should be disconnected from the Charger. Refer to Section 12 for details regarding intermittent use and storage of batteries.

Intended Use

1. This Charger is designed for indoor use only and should not come into contact with water or excessive dust. To prevent overheating the product should not be covered during use.
2. The mains socket should be easily accessible. In the event of operational error, the plug should be immediately removed from the socket.
3. This Charger is designed for use with MAXAIR Lithium-Ion Batteries. For safety reasons, this Charger must be used only for MAXAIR Batteries which have the right number of cells in series: Output voltage divided by 4.1V or 4.2V.
4. The Charger contains dangerous voltages and the cover should not be removed.
5. All recommended maintenance work should be carried out by qualified personnel who can get assistance by contacting the manufacturer's agent.
6. A fuse protects the Charger against short circuiting and overloading.
7. This symbol means that the charger is double insulated (Insulation Class II)
8. If the Charger is mounted in a vehicle it can only be used when the vehicle is not in use.
9. If the Charger is labeled "EN60601-1" and therefore it complies with the requirements of electro-medical equipment, it can be used in hospital environments, etc.
10. The Charger should not be used in the vicinity of flammable gases.
11. The Charger has a plastic casing; avoid its coming into contact with oils, grease etc., as most types of plastic can be broken down by chemicals and solvents.

Charging Instructions



1. Connect the Charger (single and/or 6-Gang) to an appropriate grounded wall mains power source (120-240 VAC, 50-60 Hz) before connecting to the Battery(ies). The Charger green status LED should turn on.
2. Connect the Battery(ies) to the Charger(s) by pushing the Charger Cord Connector into the Battery Connector Receptacle until fully seated. The Charger LED should change from green to red to indicate charging. If the LED is Green after being connected to the Battery for 10 seconds, the Battery is ready for use.
3. When charging is complete, the Charger LED should change to green. Disconnect Battery(ies) from Charger(s) by pulling the Charger Cord Connector from the Battery Connector receptacle. The Battery(ies) is(are) ready for use.

WARNING

The Charger has internal fuses which blow if a fault occurs in the charger. Additionally, the Charger is equipped with a fuse switch which cuts off the unit in the case of a reverse polarity connection to the Battery. If a Charger fails, contact Customer Service at 1-800-443-3842 for a Return Material Authorization (RMA).

2600-01 LED Indicator and Charging Characteristics

Fast charge (Red LED)

- The charger is in constant current mode.
- Charge current is at the maximum.

Final charge (Red LED)

- The charger is in constant voltage mode.
- Charge current is less than the maximum.
- The battery is normally 80-95% charged.
- The charger stays in this mode until the charge current decreases to charge termination level.

Charge completed (Green)

- The charge is stopped.
- Charge current is zero.

Charging Diagram

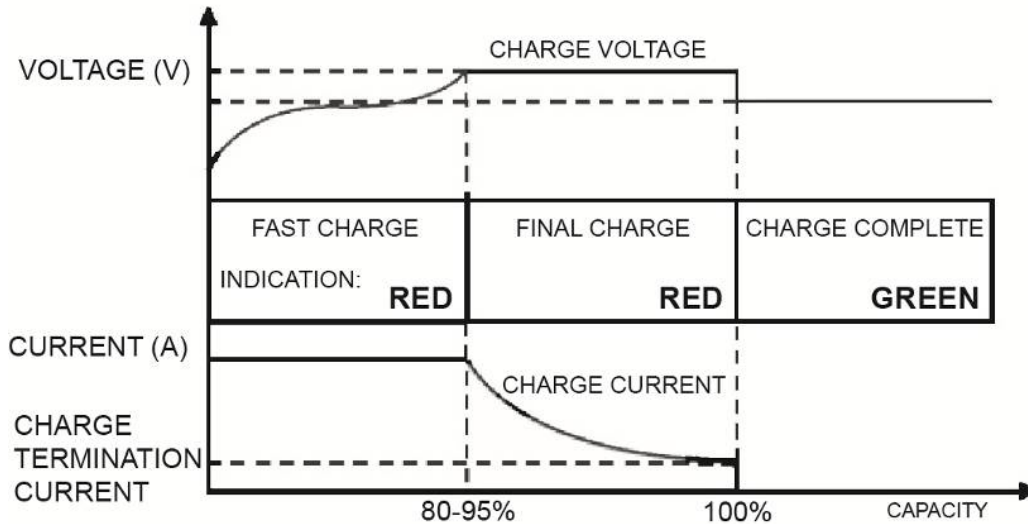

2600-02 LED Indicator and Charging Characteristics

Step 1 - Constant Current Charge cycle starts automatically when connected to mains and battery is connected to charger. Charging is with maximum charger current. The LED is YELLOW. This allows rapid charging to 80-95% capacity.

Step 2 - Constant Voltage (Timer) Charge. Charge voltage is constant and charge current is decreasing. The LED is FLASHING YELLOW. This continues until current has decreased to end of charge detection level of until Timer runs out (8 hours). The battery is charged to full capacity.

Step 3 - Charge Complete. The LED turns GREEN, the battery is fully charged, the charge current is zero, and the battery has been charged to its full capacity. A new charge cycle will be initiated if battery voltage decreases with 0.1 V/ cell.

FLASHING GREEN - Battery not connected.

3 Red Blinks - Charger output is shorted.

4 Red Blinks - Battery voltage low and may need replacing.



Indicator view



Label view

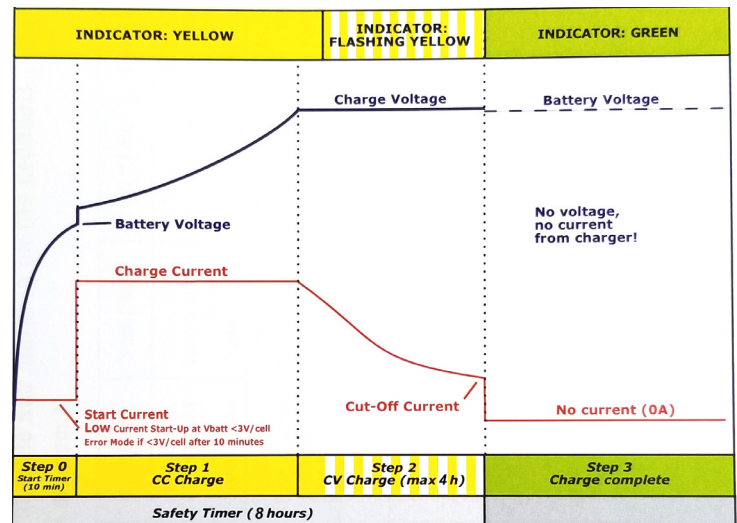

Gang Battery Chargers

2601-06 6-Gang Battery Charger

Includes six 2600-01 Chargers that can be charged simultaneously from one wall power outlet.

2601-06B 6-Gang Charger Bracket

The 6-Gang Charger Bracket is for use with from one to six already purchased 2600-01 Chargers.

Installing the 6-Gang Battery Charger and Bracket

The 6-Gang Charger and 6-Gang Charger Bracket ship with basic mounting hardware for mounting into solid wood and plasterboard.

Locate a suitable location for placing them on a surface. If it is desirable to mount them to a wall, cabinet, etc., use the mounting hardware supplied.

Charging Batteries with the 6-Gang Battery Charger

Plug the power cord into a standard 110v outlet.

If necessary, connect from one to six 2600-01 Chargers into the clips, at any given time, and connect the chargers to the six-connector cable using the 1-6 charger connectors on the power cable.



NOTE

Each connected Charger's LED should be green before a Battery is connected for charging. Connect batteries to appropriate Chargers and the Charger's green LED should turn red.



NOTE

If a charger LED remains red when a Battery is connected, the Battery is charged sufficiently and is ready for use. The Charger LED should change back to green when the Battery is charged, typically in 4-6 hours for a fully drained Battery.

2600-01 (01432089)



2601-06

2600-02 (01432202)



Label View



Indicator View

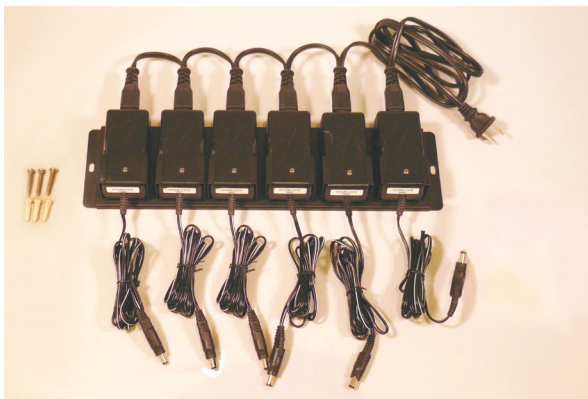

2601-06B



6. Instructions For Use: Common Protocol

6.1 Inspections Before Use

**NOTE**

If you have difficulty with the proper operation of a MAXAIR System, first check for any visible damage to the outer and inner surfaces of the helmet, and any damage to the attached helmet power cord and the battery.

**CAUTION**

Prior to each use, if any of the following issues are discovered for any system component(s), replace the particular item(s) by following the assembly/dis-assembly procedures for the particular item(s).

- Tears, breaks, dents, cracks, and any signs of stress on any system component.
- Contamination from blood or other bodily fluids not safely removed by following approved disinfection procedures.
- Any other threat to proper function.

MAXAIR Systems are reliable, essentially sealed helmet systems that do not require periodic maintenance. With careful and recommended use and adherence to all cautions, all components are expected to provide reliable service for their full useful life.

6.2 Readyng the Helmet for Use

Check the position of the Headband Comfort Strips. (See Section 5 for Comfort Strip installation and replacement instructions).

Prior to donning, adjust the Ratchet Adjustment Knob counterclockwise to expand the Headband circumference to ensure the Helmet will fit easily.

Adjust the (Elevation) Top Headband Adjustment Strap to ensure proper and secure fit of the Helmet on the head, and good visibility of the Safety Status Indicator LEDs. (See Section 9 for more detail.)

Check to ensure that the Helmet Power Cord is firmly attached to the Helmet Power Cord Connector.

If appropriate, attach the optional Chin Strap to the Helmet. Pull on each end of the Chin Strap to adjust to the desired tightness.

Familiarize yourself with the Status Indicator LEDs that indicate when MAXAIR is no longer able to maintain adequate airflow and/or Battery charge protection for the user (Section 3.2.4).

**WARNING**

Failure to heed the Status Indicator LEDs and exit immediately to a safe environment may be hazardous to the user's health.

**NOTE**

When the Helmet is initially connected to the Battery, all five LEDs should come on briefly then go off as the airflow increases to the minimum operating level.

MAXAIR Helmets are equipped with a switch which adjusts the operating airflow. When the Helmet is first turned on it will start at a low level then the airflow will increase to a preset point according to the switch position. Adjust the Air Flow Switch to suit your activity and comfort level.



7. Instructions For Use

**CAUTION**

Always ensure all system components to be used are compatible with Section 9 before handling.

7.1 Hoods

7.1.1 Hood to Helmet Compatibility

**2065-03****2025-03****2026-03****2000-25DMA**
(01031301)**2000-22A**
(01031303)**2120-10**
(01031027)**2272PB-07ML**
2272PB-07SM
(07831202, 07831173)**2270-06**
(07831038 & 07831039)**2065-03 Helmet Hoods:**

The 2000-25DMA Hood is a single shroud respiratory protection hood with integrated HE Filter.

The 2000-22A Hood is similar to the 2000-25DMA relative to donning and doffing. The 2000-22A requires the addition of the 2000-25 Pre-Filter.

2025-03 Hood:

The 2120-10 is a Double Shroud respiratory protection hood with integrated HE Filter and moderate fluid resistance.

The 2272PB-07ML (&SM) Double Shroud Hoods are for respiratory protection and higher fluid resistance.

2026-03 Hoods:

The 2270-06 is a single shroud hood with high fluid resistance.

7.1.2 2000-25DMA (01031301) and 2000-22A (01031303) with 2000-25 Pre-filter (01021084)**Assembly**

1. Remove the Filter Hood from its polybag.



2. Open the bottom of the Filter Hood and insert the back end of the Helmet into the pocket in the back end of the Filter Hood.

3. Pull the Filter Hood over the front end of the Helmet.

4. Secure the Hood alignment slot over the Helmet alignment post.

5. Snap both sides of the Hood to the Helmet by pressing the Hood snaps together with the Helmet side snaps.

Additional Assembly ONLY for the 2000-22A

6. Hook the back of the 2000-25 Pre-Filter over the back of the Helmet.



7. Pull the front of the Pre-Filter over the front of the Helmet and secure it on both sides by pressing together its Velcro strips with the mating Velcro strips on the Helmet.

Disassembly

Reverse the Assembly steps.



1. Obtain a fully charged battery. (Charger LED should be green after battery is connected to charger for more than 10 seconds.)

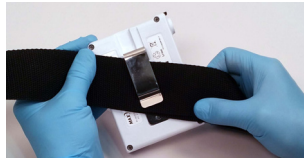

2. Assemble the battery onto the belt. Place the top edge of the Belt under the Battery Clip. Move the Belt fully under and up to the top of the Clip.



3. Place the belt comfortably around the waist with the battery near the side-back of the right hip.



4. To begin air flow, insert Helmet Power Cord Connector into Battery Connector receptacle until the Secure Connection audibly clicks.

Don the Hood

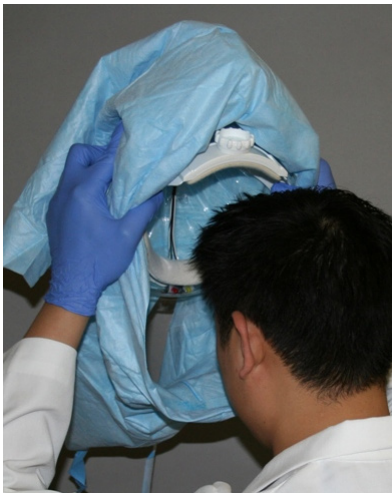

1. Flip the back side of the Filter Hood up and over the Helmet to the front. Grasp the Helmet on each side with the Filter Hood Lens facing the floor and the Rotary Adjustment Knob facing the ceiling.

≤ 1/2
inch

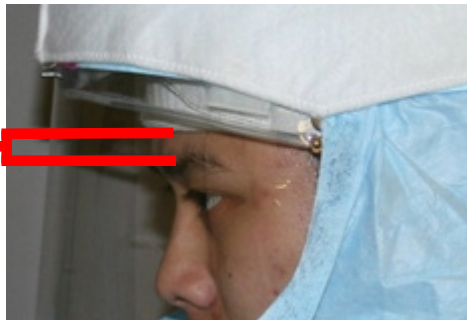

2. Place the Helmet firmly on the head. Position the Helmet so that the front headband is within 1/2 inch of the eyebrows, and the rear headband is resting under the occipital bone above the vertebrae on the neck.

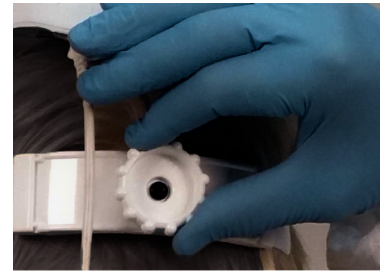

3. Tighten the rotary adjustment knob so that the headband secures the Helmet and allows a full range of head and body movement without adversely affecting the secure position of the Helmet. Do not over-tighten to cause discomfort.



4. Flip the back side of the Filter Hood back up and over the Helmet and pull it down fully in the back.

5. Tie the Filter Hood tabs tightly around the neck area to restrict air access to the neck and head area.

6. If desired, tuck the Filter Hood shroud into the outer body gown for added protection.



CAUTION

Wrap the ties around each other twice to prevent the ties from loosening.

There should be a maximum gap distance of approximately 1/4" between the neck and Filter Hood.

The user should be able to feel positive pressure airflow across the restricted neck area when the ties are adjusted correctly. The ties should draw the Hood under the chin.

Doff

To Doff the Hood reverse the Don steps.



CAUTION

Dispose of all single use products per your institutional protocol for hazardous waste.

To Doff the Helmet and Battery reverse the Don steps.

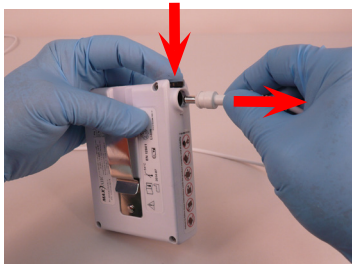

Disconnect the Helmet Power Cord from the Battery - push the Secure Connection Button down, pull Cord Connector out, release the Button.



Connect the Battery to a powered on Charger.

Assembly

1. Remove the Filter Hood from its polybag.



2. Open the bottom of the Filter Hood and insert the back end of the Helmet into the pocket in the back end of the Filter Hood.

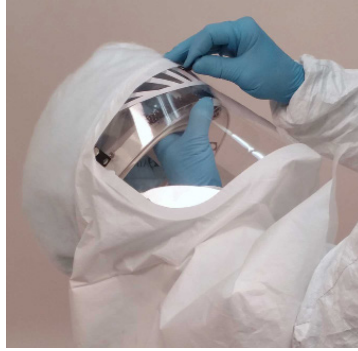

3. Pull the Filter Hood over the front end of the Helmet.



4. Pull Hood down until the front Hood Snap is over the center Helmet Snap.



5. Using the Hood Snap Pull Tabs to align the Hood Snaps over the Helmet Snaps, secure the front Snap, and then each Side Snap.



Disassembly

Reverse the Assembly steps.

Don the Battery



1. Obtain a fully charged battery. (Charger LED should be green after battery is connected to charger for more than 10 seconds.)

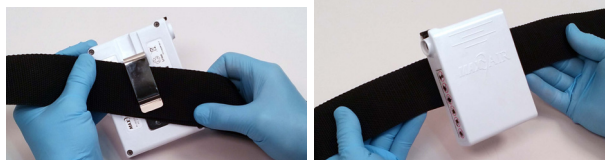

2. Assemble the battery onto the belt. Place the top edge of the Belt under the Battery Clip. Move the Belt fully under and up to the top of the Clip.



3. Place the belt comfortably around the waist with the battery near the side-back of the right hip.



4. To begin air flow, insert Helmet Power Cord Connector into Battery Connector receptacle until the Secure Connection audibly clicks.

Don the Hood



1. Flip the back side of the Filter Hood up and over the Helmet to the front. Grasp the Helmet on each side with the Filter Hood Lens facing the floor and the Rotary Adjustment Knob facing the ceiling.

< 1/2
inch



2. Place the Helmet firmly on the head. Position the Helmet so that the front headband is within 1/2 inch of the eyebrows, and the rear headband is resting under the occipital bone above the vertebrae on the neck.

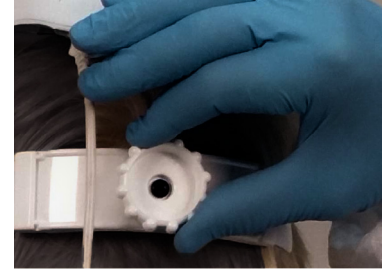

3. Tighten the rotary adjustment knob so that the headband secures the Helmet and allows a full range of head and body movement without adversely affecting the secure position of the Helmet. Do not over-tighten to cause discomfort.



4. Tuck the inner shroud inside the outer body gown, close gown completely, and leave the outer shroud outside and over the outer body gown, for maximum protection.



NOTE

The neck (top) ties may be used to restrain the lens if desired; the waist (bottom) ties may be used to adjust the fit of the outer shroud layer if desired.



CAUTION

After securing the ties, turn head side to side and up and down to check vision and head movement for safety.



5. Wrap the ties around each other twice to prevent the ties from loosening. There should be a maximum gap distance of approximately 1/4" between the neck and Filter Hood.



6. The user should be able to feel positive pressure airflow across the restricted neck area when the ties are adjusted correctly. The ties should draw the Hood under the chin.

Doff

To Doff the Hood reverse the Don steps.



CAUTION

Dispose of all single use products per your institutional protocol for hazardous waste.

To Doff the Helmet and Battery reverse the Don steps.

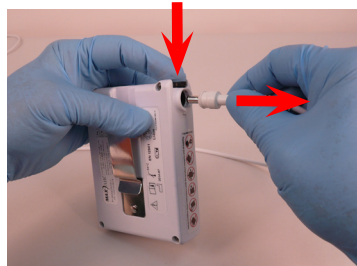

Disconnect the Helmet Power Cord from the Battery - push the Secure Connection Button down, pull Cord Connector out, release the Button.



Connect the Battery to a powered on Charger.

HE Universal Hood: REF 2270-06SM, P/N 07831038; REF 2270-06ML, P/N 07831039

The 2270-06 HE Hood is used with a 2167-26 Heavy Loading Filter (HLF) on the 2026-03 Helmet with ChinBar and a 2367-02 Quick Cuff.

Assembly: ChinBar

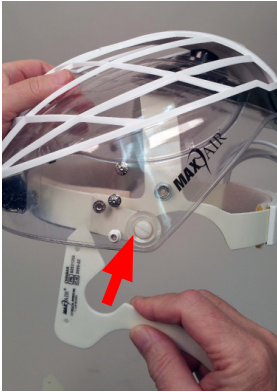

1. Remove ChinBar from the packaging. Wedge the pointed end of the labeled end of the ChinBar between the Helmet and the Headband and move the ChinBar inner curve towards the Headband-to-Helmet Attachment Bolt.

2. Slide the ChinBar against the Attachment Bolt and turn the ChinBar clockwise to move the rear ChinBar Attachment Hole towards the forward Helmet Snap (towards Helmet front).

3. Ensure the rear ChinBar Attachment Hole is under the forward Helmet Snap (towards Helmet front).



4. Press the Helmet and ChinBar together where the Snap and Snap Hole are overlapped to secure the ChinBar to the Helmet.



5. Repeat step 1 for the other side of the ChinBar and Helmet.



6. Repeat step 2 for the other side of the ChinBar and Helmet.



7. Repeat step 3 for the other side of the ChinBar and Helmet.



8. Repeat step 4 for the other side of the ChinBar and Helmet.



9. Completed assembly creates the 2026-03 Helmet and it is ready for use with the 2367-03 Quick Cuff and appropriate Headcovers.



NOTE

To disassemble the ChinBar from a Helmet, reverse steps 1-8.

Assembly: Quick Cuff to ChinBar



1. Remove Quick Cuff from packaging and lay on the counter with label facing up.



2. Ensure proper orientation of Quick Cuff Snaps by holding up in front of ChinBar with label facing you.

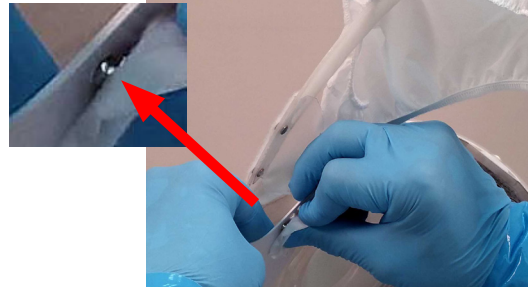

3. With Helmet turned upside down, snap one side of Quick Cuff to the Helmet Headband Snap Hole.



4. Snap other side of Quick Cuff to Helmet other side Headband Snap Hole.



5. Gently pull top of one side of Quick Cuff up and over bottom of Velcro on ChinBar.



6. Gently pull top of other side of Quick Cuff up and over bottom of Velcro on ChinBar on other side.



7. With bottom of ChinBar pointed up, pull bottom of Quick Cuff down and mate the bottom inside Quick Cuff stitching to the velcro strip on the ChinBar.



8. Finished assembly should appear as shown.

Disassembly

To disassemble Quick Cuff for replacement reverse Quick Cuff assembly steps 2-7 and discard per institutional protocol for contaminated waste.

Prep for Donning the 2270-06 Hood



1. Remove Hood and Heavy Loading Filter from packaging and lay on a counter with labels facing up.

Start with the 2270-06ML unless the wearer is of small stature.



NOTE

Depending on the anticipated comfort level when fully gowned, the Helmet Air-Flow Level may be set to Med or High.

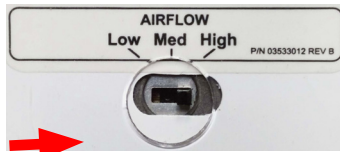

NOTE

The outer gown may be donned up to about the waist before donning the battery, and then completed, or fully after the battery is donned and connected.

Don the Battery

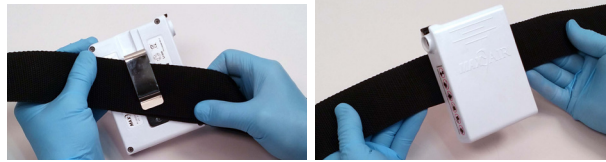

1. Obtain a fully charged battery. (Charger LED should be green after battery is connected to charger for more than 10 seconds.)

2. Assemble the battery onto the belt. Place the top edge of the Belt under the Battery Clip. Move the Belt fully under and up to the top of the Clip.

3. Place the belt comfortably around the waist with the battery near the side-back of the right hip.

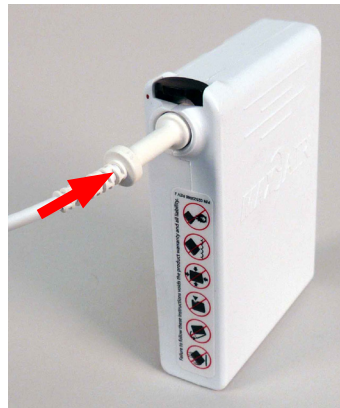

4. To begin air flow, insert Helmet Power Cord Connector into Battery Connector receptacle until the Secure Connection audibly clicks.



1. Turn Headband Ratchet Knob counterclockwise to loosen headband for ease of donning Helmet.

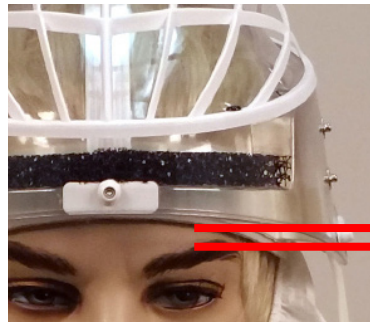

2. Position Helmet on head with front Headband within 1/2 inch of eyebrows.

≤ 1/2 inch
(~ 12.7 mm)

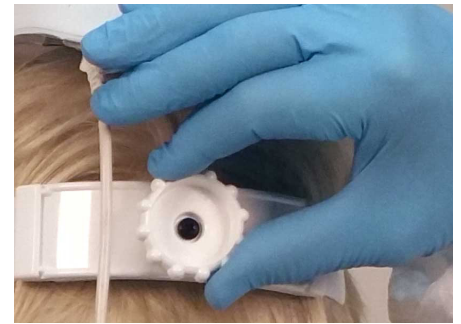

3. Turn Ratchet Knob clockwise to tighten Headband as tight as comfortable to secure Helmet to Head for all anticipated activities.



4. Hold Hood in one hand with lens towards helmet. Attach one side Hood-Lens attachment hole to respective Helmet side attachment post.

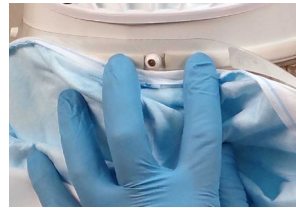

5. Attach center Hood-Lens alignment hole over Helmet center alignment post.

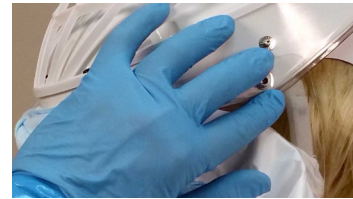

6. Attach other Hood-Lens attachment hole to other Helmet side attachment post.

NOTE
An audible click will occur when the side attachments are made properly.



7. Holding the Helmet securely on head, grasp back bottom of Hood Skirt and pull up, over, and down below Helmet in back.



8. Continuing process of 7, pull Hood all the way down so that Hood Filter (blue) is fully down on Helmet.



9. Ensure all Filter (blue) wrinkles above front of Lens are removed by holding shroud in front below lens and in back below filter and pulling down firmly.



CAUTION

For very small stature wearers the Hood Shroud may fit too loosely, and the 2270-06SM may be more appropriate.



10. Initiate donning of Heavy Loading Filter (HLF) by tucking back bottom up under back bottom of Helmet



11. Complete donning of HLF by pulling down rear-to-front and securing front bottom on Hood front Velcro strips (both sides in front).



12. Ensure Hood Skirt is fully down on all sides.
Secure Neck ties to within about 1/2 inch of neck.
Secure body ties around waist area.

Doff the System



1. Untie both Neck and Body Ties.
Either re-tie Neck ties very loosely or cut them off Hood to ensure Neck Ties do not contaminate Helmet, gown, or wearer.



2. Grasp both Body Ties and pull up to bring back bottom of Hood up and over Helmet.



3. Continue pulling Hood inside-out and over Hood and HLF to ensure contaminated outside is folded up inside.



4. Continue pulling Hood off front of Helmet releasing the Lens from its Helmet attachment points.



5. Discard Hood and HLF per institutional protocol for contaminated waste.



6. Doff and discard gown per gown supplier protocol.



7. Loosen Headband by turning Ratchet Knob fully counter-clockwise.



8. Lift Helmet up and off Head

9. Dispose of all single use products per your institutional protocol for hazardous waste.

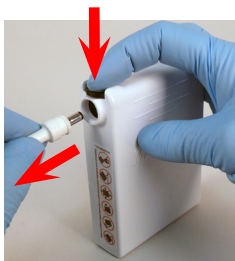

10. Disconnect the Helmet Power Cord from the Battery - push the Secure Connection Button down, pull Cord Connector out, release the Button.



11. Connect the Battery to a powered on Charger.

7.1.5 2272PB-07ML, 2272PB-07SM Hoods



REF 2272PB-07SM
Small-Medium
(P/N 07831173)

REF 2272PB-07ML
Medium-Large
(P/N 07831202)

Intended Use

The MAXAIR® CAPR® 2272 Series Hood Systems are intended to filter aerosolized and droplet particulates and provide full head and neck contact protection.

Hoods are designed for single use applications.

Typical Hood System Components



1. 2025-03 Helmet
2. 2061-05 HFR FCC
3. 2272PB-07 Hood w/ HLF
4. 2500-37TSC Battery ¹
5. 2000-76 Battery Belt
6. 2600-01 Battery Charger

¹ The 2500-36TSC is an alternate to the 2500-37TSC.



Hood donned with optional 2061-05 HFR-FCC (High Fluid Resistance Filter Cover Cap)

Regulatory

NIOSH

Don Battery, Belt, Helmet and Hood

1. Remove all System Components from their packaging, ensure they are ready for use, and lay them on a clean counter with labels facing you.

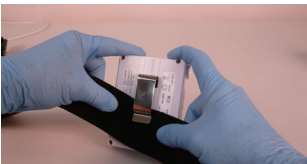

2. Assemble the Battery onto a double layer of Belt. Place the top edge of the Belt under the Battery Clip, fully under and up to the Clip top, so the Clip Detent rests on the Clip Base and NOT the Belt. Place the belt comfortably around the waist with the battery near the side-back of the right hip.

3. Connect the Helmet Power Cord to the Battery. Push the Power Cord Connector into the Battery Receptacle until the Secure Lock audibly clicks. (Do NOT hold down the Black Secure Lock Button.)



4. Turn the Headband Ratchet Knob counterclockwise to loosen Headband for ease of donning Helmet.

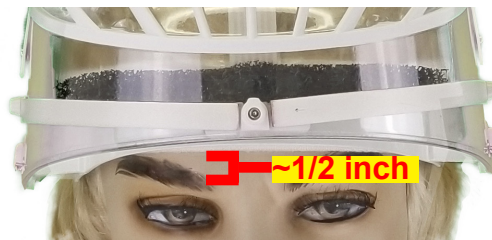

5. Position Helmet on head with front Headband within 1/2 inch of eyebrows.



6. Turn Ratchet Knob clockwise as tight as comfortable to secure Helmet to Head for all anticipated activities.

7. Don the appropriate body covering and gloving PPE for your application per the manufacturers' instructions.

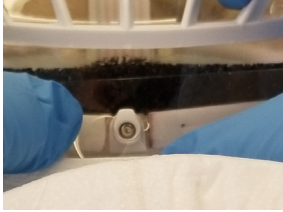

8. Attach (snap) center Hood-Lens mounting hole over Helmet center mounting post.

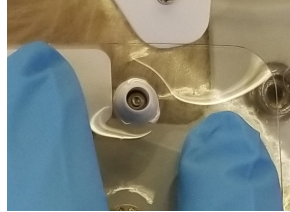

9. Attach (snap) one side Hood-Lens mounting hole to respective Helmet side mounting post. Repeat on other side.



10. With outer gown open to allow later tucking in inner Shroud, grasp back bottom of both Shrouds and pull up, over, and down below Helmet in back.



11. Continuing process of 14, pull Hood all the way down so that Hood Filter (top) is fully down on Helmet.

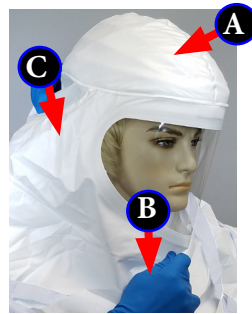

12. Ensure all Filter (top) folds above front of Lens (A) are removed by holding Hood body in front below Lens (B) and in back below Filter (C) and pulling down firmly in back.



13. Tuck Hood inner Shroud under the outer body gown and secure the gown closure. Pull Hood outer Shroud over the shoulders and body.

Don HLF (NOT optional - Required per NIOSH Approval)



1. Initiate donning the HLF (Heavy Loading Filter) by tucking its back bottom up under back bottom of Helmet



2. Complete by pulling HLF over and down, rear-to-front, of the Helmet and securing front bottom on Hood front Velcro strip.



3. Ensure Hood outer Shroud is fully down on all sides, secure neck ties to within about 1/2 inch of neck, and feed body ties through front Hood Shroud slits and tie securely.

Don HFR/FCC (Optional, depending upon fluid resistance protection desired.)



1. Initiate donning the HFR FCC (High Fluid Resistant Filter Cover Cap) by placing it over the front of the Helmet and down towards the back.



2. Continue bringing the HFR FCC down over the Helmet so that it covers the HLF.

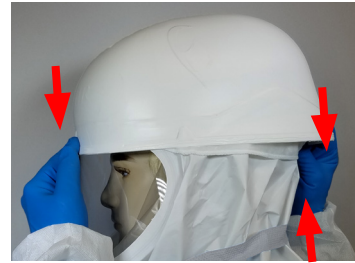

3. As needed, pull down back of HFR FCC with fingers in back while pushing up on under side of Helmet back with thumb.



Doff HFR FCC (If it was Donned)



1. Hold HFR FCC front and lift its rear up over Helmet.



2. Remove HFR FCC completely and decon for next use.

Doff HLF

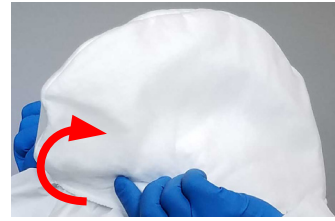

1. Begin HLF doffing by curling its back bottom up over Helmet back bottom.

2. Either continue grasping the HLF and lift it up, over, and off the Helmet and discard appropriately, or, **ALTERNATIVELY,** you may temporarily leave it on the Hood and proceed to Doff it with the Hood (next section).

Doff the Hood, Helmet, and Battery and Belt



1. Untie both neck and body Ties.



2. Pull both ties forward and off the hood and discard appropriately for contaminated waste.



3. Lift up Hood outer Shroud and open outer body gown sufficient to allow Hood inner Shroud to be pulled up and out. (HLF is on, or off per previous Doff HLF step)



4. Pull the Hood body, just below the Filter, back and up to lift the back of the Filter up over the back of the Helmet.



5. Continue pulling Hood up to begin lift off of the HLF (if not already removed) and roll up the back bottom of the Hood, to pull non-contaminated inside over contaminated outside.



6. Continue rolling Hood inside-over-outside, rolling up, over, and forward of the Helmet. (HLF will be rolled up inside of Hood if it was left on.)



7. Continue the rolling process while moving the entire Hood (and HLF) over, off, and forward from the Helmet.

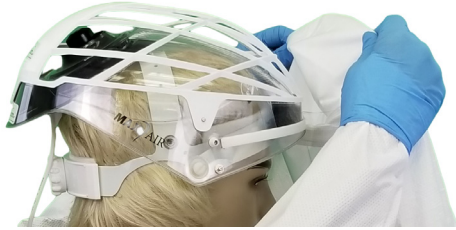

8. Continue the rolling process until the Hood is at the front of the Helmet, then lift upwards, outwards, and forward to lift the front and side Hood Lens mounting holes up and off the Helmet adapters. Discard Hood appropriately for contaminated waste.

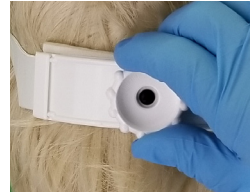

9. Turn Helmet Ratchet Knob counter-clockwise to loosen Headband and lift Helmet up, over, and off the Head, and prep the Helmet for next use.



10. Unbuckle Belt and remove Battery and Belt from around the waste.



11. Disconnect the Helmet Power Cord from the Battery - Press down on the Secure Lock (Black) Button to release, then pull the cord connector out from the Battery connection receptacle.



12. Connect a powered on Battery Charger connector to the Battery. Push connector into Battery receptacle fully - Do NOT push down on the Battery Secure Lock (Black) button.

7.2 Cuffs and Shrouds

The MAXAIR 2065-03 Helmet Filter Cover Systems provide unique filter protection and application flexibility. Filter Covers protect Filters, and their integrated lenses provide convenient attachment of Cuffs or Shrouds for application and personal protection flexibility. Filter Cover Caps protect Filter Cartridges as well.

Main Configuration Components



Helmet
2065-03
(02531219)



Filter Cap
2160-10
(01031226)



Filter Cartridge
2165-10
(01031254)



Filter Cover
2061-01
(01031148)

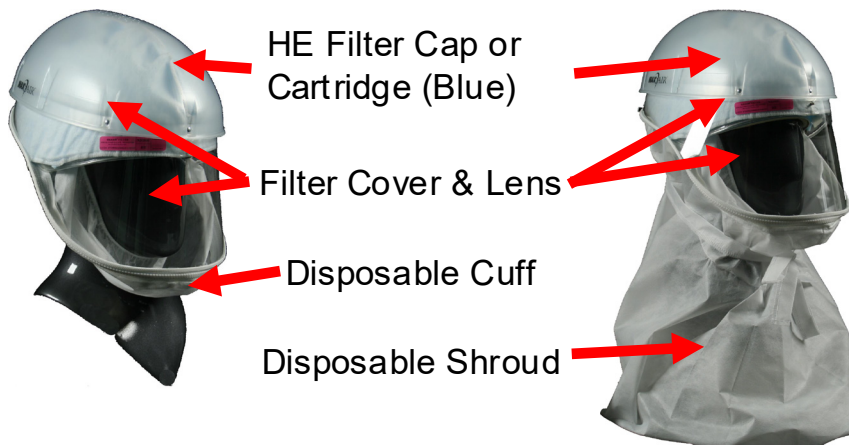

Disposable Cuffs

Disposable Shrouds

2360-01 (01031151) SM/MED

2260-01 (01031186) SM/MED

2360-02 (01031220) MED/LG

2260-02 (01031217) MED/LG

Assembly: 2160-10 Filter (01031226) and 2061-01 Filter Cover (01031148)

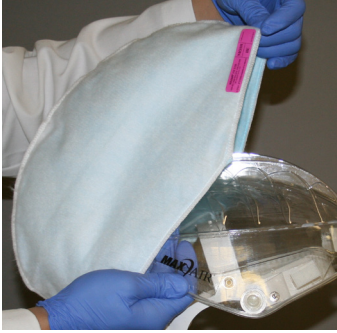

1. Insert back end of Helmet into the pocket in the back end of the Filter.



2. Pull the front of the Filter down over the front of the Helmet, pulling the Filter alignment hole over the center Helmet alignment post of the Helmet.



3. Secure the Velcro pads on each side of the Filter to the respective Velcro strips on the sides of the Helmet by pressing them together.



4. Place the Filter Cover on top of the Helmet. Insert the Helmet alignment post into the Filter Cover alignment hole and gently push it down.



5. Secure the Filter Cover to the Helmet in the back by pulling the straps under the back of the Helmet and snapping them together.

Disassembly

Reverse the Assembly steps

Assembly: 2360-01SM/2360-01ML Cuff (01031316/01031291) or 2260-01/2260-02 Shroud (01031186/01031217)



1. Push the Helmet cord through the buttonhole in the Cuff, or Shroud, from the inside to the outside.



2. Align the zipper on the Cuff, or Shroud, with the mating zipper on the Filter Cover Lens and zip the Cuff or Shroud to the Lens.



3. Tuck the back end of the Cuff, or the Inner Cuff of the Shroud, over the top strap of the headband. (For the Shroud, turn the Helmet upside down and turn the shroud inside out to gain access to the inner Cuff of the Shroud.)



1. Obtain a fully charged battery. (Charger LED should be green after battery is connected to charger for more than 10 seconds.)

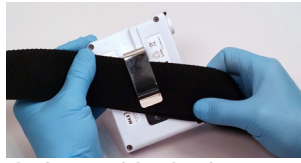

2. Assemble the battery onto the belt. Place the top edge of the Belt under the Battery Clip. Move the Belt fully under and up to the top of the Clip.



3. Place the belt comfortably around the waist with the battery near the side-back of the right hip.

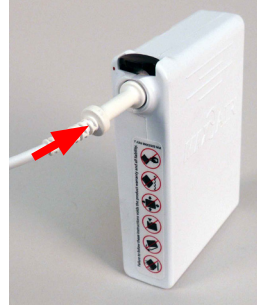

4. To begin air flow, insert Helmet Power Cord Connector into Battery Connector receptacle until the Secure Connection audibly clicks.

Don the Cuff or Shroud



1. Adjust the Helmet Rotary Adjustment Knob counterclockwise to insure the headband will easily fit over the head.

2. Hold the Helmet in one hand and pull down on the front of the Cuff elastic (the inner Cuff elastic on the Shroud) with the other hand to make an opening for the head.



3. Place the head into the Cuff opening while pulling the Helmet onto the head.

Place the Helmet firmly on the head. Position the Helmet so that the front headband is within ½ inch of the eyebrows, and the rear headband is resting under the occipital bone above the vertebrae on the neck.

Tighten the rotary adjustment knob so that the headband secures the Helmet and allows a full range of head and body movement without adversely affecting the secure position of the Helmet. Do not over-tighten to cause discomfort.



CAUTION

The elastic on the Cuff must be sufficiently tight to provide a seal around the wearer's head.

The Cuff elastic should always hold snugly against the wearer's chin or neck. The fit in front of the ears should be visibly inspected to evaluate the correct fit. A small gap of less than ¼ " x ½ " (.5 cm x 1 cm) is acceptable.



NOTE

Users with small faces may need to use the SM/MED versions of the Cuff or Shroud to achieve an adequate seal.

Only for Shroud Configurations:



4. The Shroud tabs tightly around the neck area to restrict air access to the neck and head area.

Wrap the ties around each other twice to prevent the ties from loosening.



5. There should be a maximum gap distance of approximately 1/4" between the neck and Hood. The user should be able to feel positive pressure airflow across the restricted neck area when the ties are adjusted correctly. The ties should draw the Hood under the chin. If desired, tuck the Hood shroud into the outer body gown for added protection.

Doff

To Doff the Cuff or Shroud reverse the Don steps.



CAUTION

Dispose of all single use products per your institutional protocol for hazardous waste.

To Doff the Helmet and Battery reverse the Don steps.

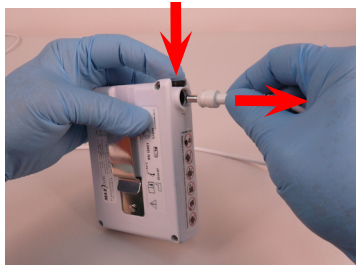

Disconnect the Helmet Power Cord from the Battery - push the Secure Connection Button down, pull Cord Connector out, release the Button.



Connect the Battery to a powered on Charger.

8. Conversion to Dual Filter Shroud Configuration

These conversion instructions for the 2065-03 Helmet from a Cage top to a 2165-10 Filter Cartridge top for use with the 2160-10 Filter only pertain to the configuration covered by NIOSH TC-21C-0813.

Disassembly: Filter Frame (01031269)

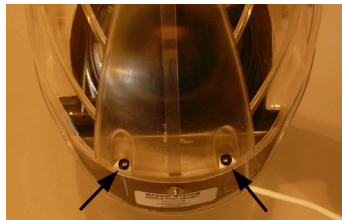

1. Remove the four black rivets attaching the Cage to the Helmet. There are two rivets in the back, and two in the front (black arrows).



2. Using a thin, flat blade (small screwdriver etc.) pry each rivet up and out of the Cage.

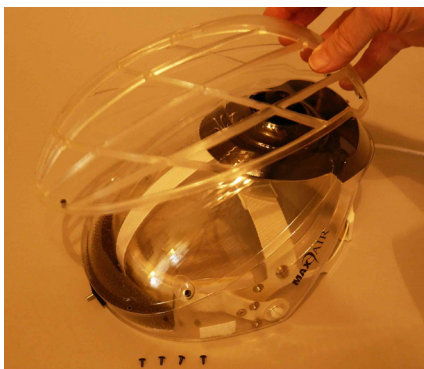

3. Lift the Cage up and off the Helmet.

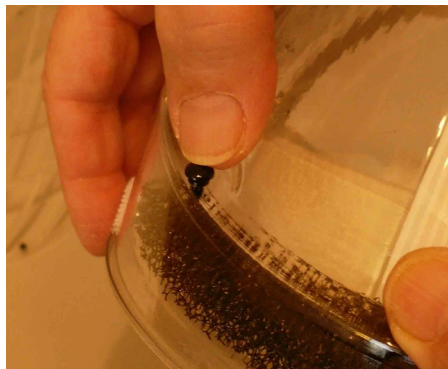

4. Place new rivets into each of the locations where the four were removed in step 1. Place the tip of the rivet in the hole and press down on the rivet head firmly until the rivet is firmly seated in the hole.

Assembly: 2165-10 Filter Cartridge (01031254) to the 2065-03 Helmet (02531219)



1. Assemble the Filter Cartridge to the Helmet by first snapping the Cartridge rear snap tab to the rear Helmet snap.

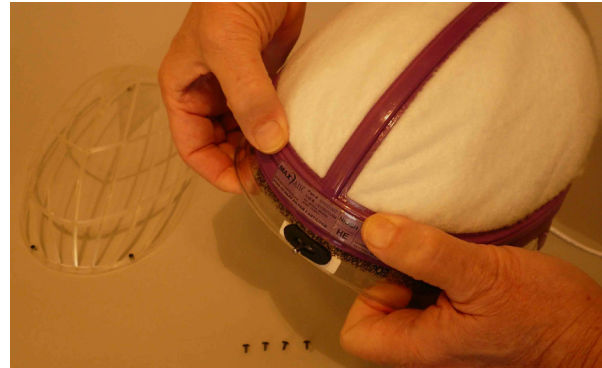

2. Gently press the Cartridge Retainer Ring (purple band around the bottom circumference of the Cartridge) to ensure it is fully down on the Helmet.

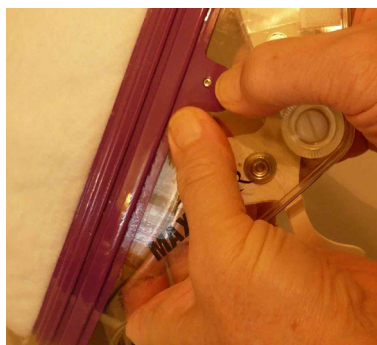

3. Snap one side Cartridge snap tab to the respective Helmet side snap, then the other. The Filter Cartridge is then fully in place.

Disassembly: Filter Cartridge

The Filter Cartridge may be removed for replacement by reversing Filter Cartridge assembly steps 1-3 immediately above.

Assembly: 2160-10 Filter to the Helmet over the 2165-10 Filter Cartridge



1. Tuck the rear of the Filter up under the Helmet back; pull the Filter forward over the Helmet.

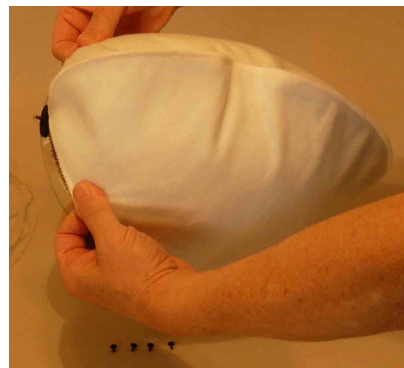

2. Work each side of the Filter gently to bring it all the way forward, over, and down onto the Helmet.



NOTE

If the rear of the Filter is not sufficiently up under the rear of the Helmet (Step 1), much resistance will be felt in the next step that could result in tearing of the Filter.



3. Pull the Filter forward and place the Filter Front Alignment Hole over the Helmet Front Alignment Post .



4. Pull the Filter down around all sides of the Helmet and ensure that each bottom front-side of the Filter is pressed over each Helmet side front Velcro tab.

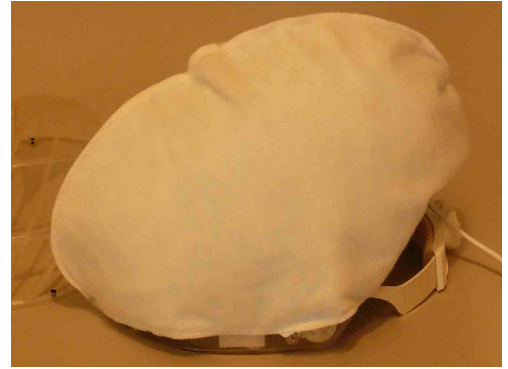

5. The Filter and Filter Cartridge are now in place.



NOTE

After converting the helmet to the Filter Cartridge plus Filter configuration, complete the system by adding the Filter Cover and Shroud (See section 7.2).

Disassembly: Filter

The Filter may be removed for replacement by reversing Filter assembly steps 1-5 immediately above.

9. Decontamination / Cleaning



CAUTION

Do not immerse the battery, helmet and fan module into water or other liquid. This will cause irreparable damage to the helmet.

Do not use solvent or alcohol to clean the helmet. Isopropyl alcohol may be used to clean the Helmet. However, repeated long term use of isopropyl alcohol may deface the Helmet.

Do not subject helmet to any sterilization cycles.

Do not use organic solvents or strong oxidizing agents to clean the helmet.

The air channels should never need cleaning. If they do, the Filters are not being maintained properly or replaced at the appropriate intervals.

If other cleaning agents are to be used, it is recommended to test their use on a small section of one Lens and/or a small section of the Helmet to determine short and long term side effects.

It is not recommended to disconnect the Power Cord from the Helmet. The Power Cord should be decontaminated and cleaned as part of the Helmet.

Decontaminating

Supplies Needed:	Frequency:	Accomplishes:
<ul style="list-style-type: none"> Decontaminating wipe Decontaminating Agent: Alcohol, bleach, or quaternary ammonia. 	<ul style="list-style-type: none"> Wipe between uses and between different users wearing the system. 	<ul style="list-style-type: none"> Reduces cross contamination. Extends useful life. Improves hygiene.
Procedure:		
1. Inspect the system and perform any assembly/dis-assembly instructions necessary for disposable items and for all components that have become worn or damaged.	2. Apply a suitable wipe with a decontaminating agent over all outside reachable surfaces, and then over all inside surfaces.	3. Let air dry and re-assemble or place in storage.



NOTE

If desired, replace the Head/Face Cover, the Filter and/or the Filter Cartridge, or the Filter Cover by following their assembly and dis-assembly procedures.

Replace the Front and Rear Headband Comfort Strips with a new ones.

Cleaning

Supplies Needed:	Frequency:	Accomplishes:
<ul style="list-style-type: none"> Clean Damp Cloth Cleaning Agent: Mild application of skin friendly soap. 	<ul style="list-style-type: none"> Wipe between uses and between different users wearing the system. 	<ul style="list-style-type: none"> Reduces cross contamination. Extends useful life. Improves hygiene.
Procedure:		
1. Use a damp cloth with cleaning agent to clean all outer and inner exposed surfaces.	2. Let air dry.	



NOTE

If desirable, replace the damaged or soiled Front Headband Comfort Strip.

10. General System Maintenance and Storage



CAUTION

Prior to each use, if any of the following issues are discovered for any system component(s), replace the particular item(s) by following the assembly/dis-assembly procedures for the particular item(s).

- Tears or Breaks.
- Contamination from blood or other bodily fluids not safely removed by following approved disinfection procedures.
- Damage or distortion to the filter cartridge gasket.
- Filter is soiled or challenged with particulates such as to compromise its performance or cause the yellow LED to be lighted.
- Compromise between the filter cartridge and helmet seal.
- Any other damage and threat to proper function.



NOTE

The complete MAXAIR System and all components and accessories should be stored indoors in a safe, clean and secure environment at all times, protected from adverse environmental conditions, i.e. conditions that would be considered incompatible with normal human working conditions without special equipment.

General System and Component Storage Environment

Temperature/ Humidity

Temperature: -20° C to +40° C

Maximum Humidity: 80% Relative Humidity.

Helmet

- If the Helmet is damaged or operating improperly, do not attempt repair. Contact Customer Service, 1-800-443-3842 for the return procedure for evaluation and possible repair or replacement.

Helmet Power Cord

- If the Helmet Power Cord connectors and cord insulation appear damaged in any manner, and if any cord wire is exposed, replace with a cord in good working condition. With a small pair of pliers, grasp the cord connector gently but firmly at its indented sides just above the connection to the helmet. Firmly pull straight up and away from the helmet. Replace with a new cord by grasping the same connector at the same indented sides with the thumb and first finger and press the connector firmly straight into the Helmet Connector. The Cord Connector will “click” when fully seated in the Helmet Connector.

Filter and/or Filter Cartridge

- If the either or both Filters are soiled or loaded (clogged) with particulate such as to compromise its performance or cause the Yellow LED to be lighted, or if there are tears or breaks, or if there are compromises between the seal and the Helmet, or any other damage, the they should be replaced by following the assembly and disassembly procedures for the FCC and the Filter Cartridge.
- Particular attention must be made to inspection of the Filter Cartridge (black) Gasket for any damage that could adversely affect its seal with the Helmet. If there is any damage or doubt regarding the seal, replace the Filter Cartridge.

Filter Cover (FC)

- The FC must be inspected before each use. If the FC is loosened after repeated assembly/dis-assembly such as to compromise its attachment mechanism or causes the Helmet mounting to be unstable, or if it has tears or breaks, the FC should be replaced by following its assembly and disassembly procedures.

Disposable Face and Head Covers: Cuffs, Shrouds, and Hoods

- The Face and Head Covers are designed for single use, once on/once off the Helmet. Repeated assembly and dis-assembly will compromise the attachment mechanism or cause the Helmet mounting to be unstable. These items should be discarded as contaminated waste after removal from the system and replaced by following the appropriate item assembly and disassembly procedures in this User's Instructions and the individual Instructions For Use.
- If there are any tears or breaks or fluid penetration in these items, or any issues with the visual clarity of the Lenses, they should be replaced by following the appropriate assembly and disassembly procedures.

Battery

- MAXAIR Systems Li-Ion Batteries are designed to be maintenance free. If a battery has any damage or malfunction, contact Customer Service at 1-800-443-3842, for an RMA (Return Material Authorization) for evaluation and possible replacement.
- Also refer to the next section, Battery Use and Maintenance, for additional instructions regarding Batteries.



Do not drop



Do not puncture.



Do not immerse in liquid.



Do not attempt to disassemble, open, or service.



Do not place near or in a flame.

Battery Charger

- MAXAIR Systems Battery Chargers are designed to be maintenance free. If a charger has any damage or malfunction, contact Customer Service at 1-800-443-3842, for an RMA (Return Material Authorization) for evaluation and possible replacement.



Do not drop



Do not puncture.



Do not immerse in liquid.



Do not attempt to disassemble, open, or service.



Do not place near or in a flame.

11. Battery Use, Maintenance and Storage



CAUTION

Do not store batteries for more than three months without subjecting them to normal discharge and recharge cycling. Ideally, batteries not being used routinely on a less than monthly frequency should be charge-cycled every three months, minimum.
Optimal storage for Lithium Ion batteries is at 50% charge and approximately 0°C-10°C.



CAUTION

MAXAIR Systems Lithium Ion (Li-Ion) batteries (LIBs) are secondary (rechargeable) batteries, not primary (storage) batteries.

MAXAIR Systems Li-Ion Batteries (LIBs) hold much of their charge for a year or longer. However, as with all rechargeable batteries, the amount of charge will decline slowly in use or storage (*self-discharge rate*), depending on time and temperature, and the maximum *recoverable charge* level diminishes gradually over the life of the battery.

11.1 Routine Infection Control use in med/surg and ED areas

- If LIBs are being used more than once per month, they should be connected to chargers in between uses.
- Before each use, physically inspect the LIB. If you perceive physical damage or tampering, use a different MAXAIR LIB and replace the damaged LIB as soon as possible.
- Routinely, every 3-6 months, perform the “LIB Check Procedure” (see Section 11.3.7). If this procedure results in a “Suspect LIB”, use a different MAXAIR LIB and replace the Suspect LIB as soon as possible.
- Check LIBs that are connected to MAXAIR chargers on a daily basis. If the charger LED is green, the LIB is ready for use and should be disconnected from the charger.



CAUTION

Check LIBs connected to chargers on a daily basis.

If a LIB is warm-to-hot to the touch, disconnect the LIB from the charger and replace it immediately. If this condition is ever observed, please mark the specific battery and the specific charger it was connected to when the heating was noted, and contact us for replacement. Call Customer Service, 1-800-443-3842, for return and replacement instructions.

If the charger LED is Green, the LIB is fully charged and ready for use, therefore disconnect if from the charger. DO NOT leave the LIBs on the chargers after the charger LED turns Green.

11.2 Emergency Preparedness (EP) and In-Frequent Use

- MAXAIR batteries are shipped to customers at the 50% charge level (approximately 14.6v output level). This is the approximate level recommended for long term storage of a Li-Ion batteries, and therefore what we recommend for EP use to achieve the longest overall useful life of the batteries.
 - For a new 2500-30TSC battery this represents up to 8 hours of use before recharging to a fully charged level.
 - For a new 2500-36TSC battery this represents up to 4 hours of use before recharging to a fully charged level
- For systems that may be in storage and not used for longer than a year, the battery charge should be revalidated every 3-6 months, minimum.

11.3 General Use, Maintenance, and Storage



WARNING

Failure to read and follow these instructions and guidelines may result in fire, personal injury and damage to property. Your MAXAIR LIBs need to be handled/transported, used/discharged, charged, and stored properly. Follow the safety rules listed below.

Follow these instructions and the Instructions For Use (IFU), and use MAXAIR LIBs in accordance to the warning labels on the MAXAIR LIBs to properly manage and control charging and discharging of all MAXAIR LIBs.

1. Keep MAXAIR LIBs and Chargers away from children.
2. Test MAXAIR LIBs before using to ensure they are operating properly and safely with the MAXAIR Helmet or on the MAXAIR Charger. (See Section 11.3.7).
3. As with all Li-Ion battery packs, misused and defective Li-Ion cells may explode and cause fire. If at any time a LIB starts to balloon, swell up, smoke or get hot, emit an unusual smell, change color, or appear abnormal in any other way, discontinue its use immediately, disconnect the LIB from the Helmet or Charger, and observe it in a safe place for approximately 15 minutes. If any of these conditions occur, the LIB should be replaced.



CAUTION

These conditions may result in LIB cell leakage. Since delayed chemical reaction can occur, it is best to observe the LIB as a safety precaution in a safe area outside of any building or vehicle and away from any combustible material. In the event of coming in contact with any leakage from a LIB, do not rub or touch the eyes, immediately rinse all contacted areas thoroughly with water, and immediately seek medical care. If left untreated, the LIB leakage could cause eye and other serious injury.

4. In the event of any damage or perceived damage to a LIB due to bad shipment or other reason, remove the LIB to a safe location for observation and place it in a safe open area away from any combustible material for approximately 15 minutes.
5. Do not place LIBs in direct sunshine, or use or store LIBs inside relatively closed environments (cars, etc.) in hot weather and anywhere extreme temperatures may exist. Doing so may cause the LIB to generate heat, rupture, or ignite. Using the LIB in this manner may also result in a loss of performance and a shortened life expectancy.
6. Do not use, charge or store LIBs in or near microwave ovens, high pressure containers, or conduction cookware.
7. Do not expose a LIB to water, salt water, any other liquid, or moisture, beyond air with a relative humidity between 10%-90%.
8. Do not connect the connection terminals together, even momentarily, with any material including touching with the human body.
9. Do not allow a LIB to make contact with a hard object (dropping, throwing, striking, piercing, etc.) so as to subject it to strong impact, shock, or other mechanical stress.
10. Do not open, penetrate, or attempt to dis-assemble or modify a LIB case in any manner without contacting the manufacturer. The LIB contains safety and protection devices which, if damaged, may cause the LIB to generate heat, rupture, or ignite.
11. **Do not submit to static electricity.**

11.3.1 Recommended Temperature Ranges

Degrees Centigrade		Degrees Fahrenheit		Activity
min.	max.	min.	max.	
0	54	32	129	Handling & Transporting
0	54	32	129	Use/Discharging
0	45	32	113	Charging
0	35	32	95	Storage

If recommended temperature range is exceeded, let batteries cool down or warm up, as appropriate, to ambient temperature, and ensure all condensation, if any, has evaporated before charging or use.

11.3.2 Use/Discharge

**WARNING**

Do not discharge a LIB by using any device except a MAXAIR Helmet.
The temperature range over which a LIB is to be discharged is 0° C-54° C (32° F-129° F). Use outside of this temperature range may damage the performance and reduce the life expectancy of the LIB.

**CAUTION**

When the LIB has reached its usual and customary useful life (See 11.3.6) -
Immediately discontinue use of the LIB and replace it.
Insulate the connection terminals with adhesive tape or similar material before disposal.

11.3.3 Charge

**WARNING**

Always use a MAXAIR charger when charging a LIB; never use any other type of charger for a MAXAIR LIB.
Never connect a LIB to any device other than a MAXAIR helmet or a MAXAIR charger.
Never charge a LIB outside the temperature range of 0° C to 45° C (32° F to 113° F). Charging the LIB at temperatures outside of this range may cause the battery to become hot or damaged. Charging the LIB outside of this temperature range may also harm the performance of the LIB or reduce the LIBs life expectancy. When the LIB becomes hot, the built-in safety equipment is activated, preventing charging further. Additional heating can destroy the safety equipment and can cause accelerated temperature increases, ignition, or other damage to the LIB.
Do not continue charging the LIB if it does not recharge within the maximum charging time. (See 11.3.8) Doing so may cause the LIB to become hot, rupture, or ignite.
Always charge in an isolated area, away from flammable materials.
When charging LIBs, always monitor the charging process and react to potential problems that may occur.

11.3.4 Store

**WARNING**

Store in closed containers and packaging that prevent short circuits and damage during storage or transportation.
In case of mixed storage of goods and articles, organize separate storage areas for LIBs, for example, by maintaining a distance of 2.5 meters between the LIB storage area and other goods.
Store in limited quantities and in isolated area with frequent surveillance.
Keep in a dry, cool and well-ventilated place, within the recommended storage temperature range of 0° C-35° C (32° F-95° F). Cooler and dryer environments of storage are safer and extend useful life.
The temperature range of 19° C-25° C (66° F-77° F) at 30%-50% full charge will optimize battery useful life.
Perform a boost charge and LIB Check Procedure (Appendix B.) every 3 to 6 months; this will help prevent the potential of an over-discharge.

11.3.5 Handling and Transport

Lithium-Ion batteries are classified as Dangerous Goods for the Transport by Road/Rail, Sea and Air. When considering transporting LIBs to other locations, conform to the requirements of the UN Regulation on the Transport of Dangerous Goods.

Internal transfer of Lithium-Ion batteries should follow the minimum safety rules imposed by the local legislation/regulation regarding the handling of Dangerous Goods.

When handling LIBs, use caution, specifically to avoid shorting the connector terminals.

**WARNING**

Do not exceed the temperature range of 0° C-54° C (32° F-129° F) when handling and transporting LIBs.
Do not expose battery packs to direct sunlight and/or heat for extended periods.

11.3.6 Useful Life

Li-Ion batteries begin aging when they are manufactured - not when you begin using the battery. Lithium-Ion batteries are prone to aging somewhat rapidly. The useful capacity (Recoverable Capacity) of a Lithium-Ion battery decreases about 10% to 20% each year. Therefore, Lithium-Ion batteries have a useful aging-service life of approximately four years.

Li-Ion batteries have a useful capacity-service life of 300-500 cycles (one cycle being the time of one full use from a full charge).

Therefore, the recommended useful life expectancy, or replacement schedule, for a Li-Ion battery is after four years or 300-500 discharge cycles, whichever occurs first.

11.3.7 LIB Check Procedure - MAXAIR LIB Test for Diminishing Battery Capacity

**NOTE**

A MAXAIR helmet and MAXAIR charger are required to perform this basic battery test. The helmet and power cord must be in good working order. Set the helmet Air Flow Switch to Low for the test.

**CAUTION**

If the LIB performs in one of the "Suspect LIB" categories below, discontinue using it and replace that LIB as soon as possible.

Case 1: The LIB has been connected to a charger and the charger green LED is on.

Procedure: Unplug the LIB from the charger and plug the helmet power cord to the LIB. Allow the helmet to settle for about 10 seconds.

Good LIB: The helmet runs with 3 or 2 green indicator lights on.

Suspect LIB: The helmet runs with only 1 green indicator light on.

Suspect LIB: The helmet runs with the red indicator light on.

Suspect LIB: The helmet doesn't run.

Case 2: The LIB has been in storage.

Procedure: Plug the helmet power cord to the LIB to be tested. Allow the helmet to settle for about 10 seconds.

Good LIB: The helmet runs with 3, 2 or 1 green indicator light on.

Suspect LIB: The helmet runs with the red indicator light on.

Suspect LIB: The helmet doesn't run.

Case 3: The LIB is connected to the MAXAIR Charger.

Good LIB: the LIB is felt to be about room temperature.

Suspect LIB: the LIB is warm or hot to touch.

11.3.8 Reference Information

Typical Charging Time Specifications:

Time to fully charge a fully discharged MAXAIR LIB

CHARGING TIME				
BATTERY	2600-01 Charger		2610-01 Charger	
	Typical	Maximum	Typical	Maximum
2500-30TSC	5 hrs	10 hrs	7.5 hrs	15.0 hrs
2500-36TSC	2.5 hrs	5.0 hrs	4.0 hrs	7.5 hrs

Lithium-ion Battery main components:

MSDS for Li-Ion Battery Cells available upon request. Call Customer Service, 1-800-443-3842.

11.3.9 Glossary

LIB

Lithium Ion Battery, Li-Ion Battery

Self Discharge

The rate at which the battery charge level declines while it is just sitting in storage, usually quoted as a decline in %-per-month.

Self-discharge increases with age, cycling and elevated temperature.

Discard a battery if the self-discharge reaches 30 percent in 24 hours.

Recoverable Capacity

The amount that a battery can be “fully charged back to” over time, usually quoted as a certain % of the full charge level when the battery was initially manufactured.

11.3.10 Projected LIB Level Available As A % At Initial Manufacture Versus Temperature

Year(s) Elapsed from Manufacture Date	Storage Condition: 50% charged				Storage Condition: 100% charged			
	Residual Capacity (due to Self- Discharge)		Recoverable Capacity		Residual Capacity (due to Self- Discharge)		Recoverable Capacity	
	23°C	60°C	23°C	60°C	23°C	60°C	23°C	60°C
1	96%	76%	99%	92%	90%	60%	94%	80%
2	92%	52%	98%	84%	80%	20%	88%	60%
3	88%	28%	97%	76%	70%	0%	82%	40%
4	84%	4%	96%	68%	60%	0%	76%	20%
5	80%	0%	95%	60%	50%	0%	70%	0%
Year(s) Elapsed from Manufacture Date	Self-Discharge Loss		Permanent Capacity Loss		Self-Discharge Loss		Permanent Capacity Loss	
	23°C	60°C	23°C	60°C	23°C	60°C	23°C	60°C
1	4%	24%	1%	8%	10%	40%	6%	20%
2	8%	48%	2%	16%	20%	80%	12%	40%
3	12%	72%	3%	24%	30%	100%	18%	60%
4	16%	96%	4%	32%	40%	100%	24%	80%
5	20%	100%	5%	40%	50%	100%	30%	100%

12. Disposal



WARNING

Dispose of potentially contaminated disposable components, DLCs, DLC-Shrouds, DLC-Hoods, Filter Cartridges, etc., in accordance with approved institutional protocol for medical waste and current local regulations.



Lithium-Ion Rechargeable Batteries contain toxic chemicals and must be disposed of following current local regulations, and your local recycling program. Additional information may be found at earth911.com and ecyclingcentral.com.





Helmets and Battery Chargers contain electronic components and must be disposed of following current local regulations, and your local recycling program. Additional information may be found at earth911.com and ecyclingcentral.com.



13. Accessories and Alternate/Replacement Parts

Accessories

#	CATALOG NUMBER	Description	QTY	
1	2000-204	Helmet Hooks	6/pkg	
2	2000-SB	System (Carry) Bag	1/Box	

Helmets and Helmet Accessories

#	CATALOG NUMBER (NIOSH NUMBER)	Description	QTY	
1	2065-03 (02531219)	Helmet Single Post	1/Box	
2	2061-01 (01031148)	Filter Cover for 2065-03	3/box	
3	2025-03 (02531222 2590-01)	Helmet Tri-Snap with Filter Frame	1/Box	
4	2026-03 (02531222 02531250 2590-01)	Helmet Tri-Snap with Filter Frame and ChinBar 02531203 01031269 02531250 2590-01	1/box	
5	2099-02 (02531250)	ChinBar	1/box	
6	2051-05 HFR FCC (01021609)	High Fluid Resistance Filter Cover Cap	1/box	

Helmets and Helmet Accessories

#	CATALOG NUMBER (NIOSH NUMBER)	Description	QTY	
6	2000-201	Comfort Strips (Front Headband)	36/box (24 full Helmet changes)	
7	2590-01	Long Power Cord (59")	1ea	
8	2590-03	59" Power Cord w/ Connector	1ea	
9	2000-203 (02531132)	Chin Strap		

NOTE

To disconnect the 2590-03:

1. Pull the spring loaded locking sleeve fully outward.
2. Pull connectors apart.
3. Release the locking sleeve.

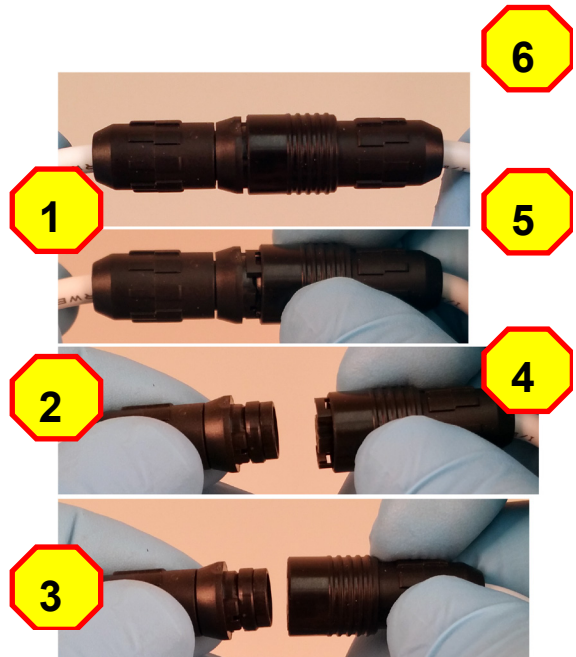







To re-connect the 2590-03:



1. Pull the spring loaded locking sleeve fully outward.
2. Gently push the connectors together while turning one until the parts mate and the male connector fully seats into the female connector.

Release the locking sleeve.



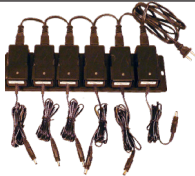
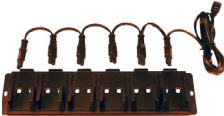

Filter and Filter Cartridges

#	CATALOG NUMBER (NIOSH NUMBER)	Description	QTY	Filter Cartridge	Battery/Batteries to Use With	
1	2160-10 (01031226)	HE Filter	10/Box			
2	2165-10 (01031254)	Post Filter Cartridge	3/Box			
3	2000-25D (01021284)	Pre-Filter	10/box			
4	2167-10 (07831040)	Heavy Loading Filter	20/box			





Chargers

#	CATALOG NUMBER (NIOSH NUMBER)	Description	QTY	
1	2600-01 (01432089)	Battery Charger	1/box	
2	2600-02 (01432202)	Battery Charger	1/box	
3	2601-06 Gang Charger includes six 2600-01 Chargers	6 Gang Charger	1/box	
4	2601-06B Bracket for up to six 2600-01 Chargers, purchased separately	6 Gang Charger Bracket	1/box	



Batteries and Belts

#	CATALOG NUMBER (NIOSH NUMBER)	Description	QTY	
1	2500-36TSC (01532104)	Li-Ion Battery 4 Cell	1/Box	
2	2500-30TSC (01532116)	Li-Ion Battery 8 Cell	1/Box	
3	2500-37TSC (01532161)	Li-Ion Battery 4 Cell	1/Box	
4	2000-76	Battery Belt	1/Bag	

Face Seals and Head Covers

#	CATALOG NUMBER (NIOSH NUMBER)	Description	QTY	
1	2360-01 (01031151)	Disposable Cuff – Small/Medium	20/Box	
	2360-02 (01031220)	Disposable Cuff – Medium/Large	20/Box	
2	2367-02 (07631022)	Quick Cuff	40/box	
3	2260-01 (01031186)	DLC Shroud – Small/Medium	20/Box	
	2260-02 (01031217)	DLC Shroud – Medium/Large	20/Box	
4	2000-25DMA (01031301)	HE Hood	20/box!	

Face Seals and Head Covers

#	CATALOG NUMBER (NIOSH NUMBER)	Description	QTY	
5	2000-22A (01031303)	Hood	20/box	
6	2120-10 (01031027)	HE Hood, Double Shroud	20/box	
7	2270-06SM (07831038)	HE Hood, Small/Medium	20/Box	
	2270-06 ML (07831039)	HE Hood, Medium/Large	20/Box	
8	2272PB-07ML (07831202)	XP Hood, Medium/Large	10/Box	
	2272PB-07SM (07831173)	XP Hood, Small/Medium	10/Box	

14. Specification

Specifications listed are approximate and may vary slightly from unit to unit or by power supply fluctuations and/or tolerance of the controller.

2065-03, 2025-03, 2026-03 Helmet Based systems		
#	PROPERTY	SPECIFICATION
1	Complete Device Classification	PAPR, Loose Fitting
2	EMC Classification (IEC 60601-1-2:2007; EN 60601-1-2:2007)	Class A for Emissions; Immunity for Not Life-Supporting Equipment
3	Storage Temperature Range	-20 to 40°C
4	Storage Maximum Humidity	80% RH
5	Fit Factor	Minimum 500
6	Maximum allowable Percent Leakage: Dioctyle-Phthalate Test	0.03% @ 107 LPM
7	Minimum allowable NaCl efficiency	99.97% @ 125 lpm
8	Minimum Airflow	170 LPM
9	Battery	Lithium-Ion
10	Noise Level	80 dBA limit
11	Total Mass/ Total Mass on Head	1.25 kg/ 0.75Kg
12	2164-10 Filter Classification	HE*

*For reliable operation and desirable useful run time, Bio-Medical Devices Intl does not recommend Filter Cartridge use against particulate aerosols containing oil unless specifically so labeled.

2500-30TSC/ 2500-36TSC Battery Specification		
IPXO Ordinary Equipment Duty Cycle: Continuous Operation.		
#	PROPERTY	SPECIFICATIONS
1	Minimum Continuous Operating Time: 2500-36TSC	4 Hrs. (Typical 8-10 hr./Charge)
2	Minimum Continuous Operating Time: 2500-30TSC	8 Hrs. (Typical 16-20 hr./ Charge)
3	Charge Input	16.8V; 1A
4	Electrical Output: 2500-36TSC	14.8V; 2.2Ah
5	Electrical Output: 2500-30TSC	14.8V; 4.4Ah
2600-01 Charger Specification		
#	PROPERTY	SPECIFICATIONS
1	Complete Charge for 2500-36TSC or 2500-30TSC	4-6 Hours for a Fully Drained Battery
2	Electrical Output	Up to 16.8V; Up to 0.9A
3	Electrical Input	100-240 VAC; 50-60Hz; 0.3A

