



User Instructions

eCAPR Systems

SYNTECH INTL

17171 Daimler Street • Irvine, CA 92614 • 800-443-3842 • www.syntech-intl.com



Copyright© Syntech International, Inc. All rights reserved.

For more Information:

U.S/ Canada/International

Telephone:

800-443-3842/ 949-752-9642

Fax:

949-752-9658

Website:

www.syntech-intl.com

E-mail:

info@syntechintl.com

Shipping/ Mailing Address:

Syntech International, Inc.
17171 Daimler Street
Irvine, CA 92614
USA

**** IMPORTANT - Please note WARRANTY AND TERMS AND CONDITIONS
regarding your MAXAIR Systems
by thoroughly reading the information on the MAXAIR Systems' Website ****

<http://www.maxair-systems.com> >WARRANTY



Syntech International, Inc. Disclaimer

NOTE

THE GOODS COVERED BY THIS CONTRACT HAVE BEEN PURCHASED BY THE BUYER "AS IS" AND "WITH ALL FAULTS," AND THE BUYER ACKNOWLEDGES THAT NO WARRANTIES OF MERCHANTABILITY OR FITNESS FOR ANY PARTICULAR PURPOSE ARE TO BE IMPLIED IN THIS TRANSACTION.

THIS SALE IS MADE ON THE EXPRESS UNDERSTANDING THAT THERE IS NO IMPLIED WARRANTY THAT THE GOODS SHALL BE MERCHANTABILITY OR AN IMPLIED WARRANTY THAT THE GOODS SHALL BE FIT FOR ANY PARTICULAR PURPOSE. THE BUYER ACKNOWLEDGES THAT HE IS NOT RELYING ON THE SELLER'S SKILL OR JUDGMENT TO SELECT OR FURNISH GOODS SUITABLE FOR ANY PARTICULAR PURPOSE AND THAT THERE ARE NO WARRANTIES WHICH EXTEND BEYOND THE DESCRIPTION ON THE FACE HEREOF.

THE SELLER SHALL BE IN NO WAY RESPONSIBLE THE GOODS' PROPER USE AND SERVICE, AND THE BUYER HEREBY WAIVES ALL RIGHTS OF REFUSAL AND RETURN OF GOODS.

Any affirmation of fact or promise made by Seller shall not be deemed to create an express warranty that the goods shall conform to the affirmation or promise; any description of the goods is for the sole purpose of identifying them and shall not be deemed to create an express warranty that the goods shall conform to such description; any sample or model is for illustrative purposes only and shall not be deemed to create an express warranty that the goods shall conform to the sample or model; and no affirmation or promise, or description, or sample or model shall be deemed part of the basis of the bargain.

Syntech's exclusive distributor - Bio-Medical Devices International Inc. DBA MAXAIR Systems - has a warranty and return program that can be viewed online at: <https://maxair-systems.com/terms-and-conditions>.

Trademarks MAXAIR® and CAPR® are licensed to Syntech International, Inc.



Table Of Contents

1. Warnings, Cautions, Notes, Symbols	6
1.1 Important Information	6
1.2 S- Special or Critical User's Instructions	7
1.3 SYMBOLS – General and Packaging	8
2. Regulatory Marking Definitions	9
3. Introduction	10
3.1 Part Numbers Reference	10
3.2 Approved System Configuration Components	12
3.3 eCAPR Systems	14
3.3.1 Systems and System Components	14
3.3.2 Systems Configuration Possibilities (Trees)	15
3.4 Standard System Components and Order and Part Numbers	17
3.5 Helmets	18
3.5.1 2079-03 (03531214, 03531021, 01031269,2590-05) Helmet - Common Helmet And Liner Characteristics	18
3.5.2 2079-03 Helmet with SnapOn Cage	19
3.5.3 Characteristics Details (Refer to page 18)	20
3.5.4 Helmet Symbol Definitions	22
3.6 2366-02SM/ML (01031291, 01031316) Overview	22
3.7 Battery, Belt, and Charger Overview	23
4. Unpacking Standard System Components and Parts Identification	24
4.1 Unpacking the eCAPR Helmet - 2079-03 (03531214, 03531021, 01031269, 2590-05) eCAPR Helmet	24
4.2 Unpacking the 2167-10 (01031569) Filter Cartridge	25
4.3 Unpacking the 2061-08 (01031284) Filter Cover Cap (FCC)	26
4.4 Unpacking the 2500-36TSC (01532105) Battery	27
4.5 Unpacking the 2000-76 Battery Belt	28
4.6 Unpacking the 2600-02 (01432202) Battery Charger	29
4.7 Unpacking the DLC (Disposable Lens Cuff) - 2366-02SM (0103156) and 2366-02ML (0103155)	30
5. Standard System Set Up	32
5.1 Components Check List	32
5.2 Setting Up	32
5.3 Assemble and Disassemble Components	32
5.4 Inspections	33
5.5 Warning Device: Yellow LED Air Flow Indicator Check - Bouffant Shower Cap Method	33
5.6 Warning Device: Yellow LED Air Flow Indicator Check - Tape Method	35
6. Standard System Donning and Doffing	36
7. Comfort Strips, P/N 2000-201	40
8. Li-Ion Battery	41
9. Charger, P/N 2600-02 (01432202)	42
10. Helmet, P/N 2079-03 (03531214, 03531021, 01031269, 2590-05)	45
11. Helmet Liner, P/N 2071-07 (03531148)	46
12. Filter Cartridge P/N 2167-10 (07831175)	48
13. Filter Cover Cap (FCC), 2061-08 (01031284)	49
14. Disposable Lens Cuff (DLC)	51



15.	DLC Shroud, P/N 2264-01	59
16.	2271PS-07SM DLC Hood	63
17.	Hard Hat, P/N 2061-04A	68
18.	Decontamination / Cleaning	72
19.	General System Maintenance and Storage	73
20.	Battery Use, Maintenance and Storage	75
20.1	Routine Infection Control use in med/surg and ED areas	75
20.2	Emergency Preparedness (EP) and In-Frequent Use	75
20.3	General Use, Maintenance, and Storage	76
20.3.1	Recommended Temperature Ranges	76
20.3.2	Use/Discharge	77
20.3.3	Charge	77
20.3.4	Store	77
20.3.5	Handling and Transport	77
20.3.6	Useful Life	78
20.3.7	LIB Check Procedure - MAXAIR LIB Test for Diminishing Battery Capacity	78
20.3.8	Reference Information	79
20.3.9	Charging Protection from Electrical Surges	79
20.3.10	Projected LIB Level Available As A % At Initial Manufacture Versus Temperature	80
20.3.11	Glossary	80
21.	Disposal	81
22.	Accessories and Alternate/Replacement Parts	82
23.	Specification	87

1. Warnings, Cautions, Notes, Symbols

1.1 Important Information

The words WARNING, CAUTION, and NOTE have special meanings and should be reviewed.

WARNING	The personal safety of the user may be involved. Disregarding this information could result in injury to the user.
CAUTION	These instructions point out special procedures or precautions and must be followed. Disregarding this information could result in jeopardizing the product reliability.
NOTE	Provide special information that supplements and/ or clarifies important instructions.
	A triangle with an exclamation point alerts the intended user to place extra emphasis on reading and understanding the accompanying instructions for operating, maintenance and safety information.

Warnings and Cautions



WARNING

This User's Instructions and Instructions for Use, that accompany each package of system components, including the Warnings, Cautions and Special or Critical User's Instructions, must be read thoroughly and followed carefully by all persons who have, or will have, the responsibility for using the system. The system will perform as designed only if it is used and maintained per the User's Instructions. Failure to follow the User's Instructions may be hazardous to the user's health.

NIOSH Cautions and Limitations

- A Not for use in atmospheres containing less than 19.5% oxygen, or more than 25% oxygen.
- B Not for use in atmospheres immediately dangerous to life or health.
- C Do not exceed maximum use concentrations established by regulatory standards.
- F Do not use powered air-purifying respirators if airflow is less than 4 CFM (115 LPM) for tight fitting face pieces or 6 CFM (170 LPM) for hoods and/or helmets.
- I Contains electrical parts that may cause an ignition in a flammable or explosive atmosphere.
- J Failure to properly use and maintain this product could result in injury or death.
- L Follow the manufacturer's instructions for changing cartridges, canisters and/or filters.
- M All approved respirators shall be selected, fitted, used, and maintained in accordance with MSHA, OSHA, and other applicable regulations.
- N Never substitute, modify, add, or omit parts. Use only exact replacement parts in the configuration as specified by the manufacturer.
- O Refer to User's Instructions, and/or maintenance manuals for information on use and maintenance of these respirators.
- P NIOSH does not evaluate respirators for use as surgical masks.
- S Special or Critical user's instructions and specific use limitations apply. Refer to User's Instructions before donning.

1.2 S- Special or Critical User's Instructions



WARNING **Special or Critical User's Instructions**

- NIOSH approved HE filters can be used for protection against particulate aerosols containing oil. However, Bio-Medical Devices Intl does not recommend use of MAXAIR Systems in oily atmospheres unless specifically indicated on the product.
- Do not use near flame or other heat source.
- The use of MAXAIR Systems in an alarm condition is only for immediate exit to a safe environment.
- During high energy work (exertion) rates, it is possible to over-breathe the MAXAIR System and create a negative pressure situation.
- If air flow is cut off, immediately hold your breath and immediately exit to clean air.
- In the power-off state, little or no respiratory protection is to be expected. Attempted use in this manner is an abnormal situation.
- In the powered-off state, rapid buildup of carbon dioxide and depletion of oxygen within the DLC system may occur.
- MAXAIR Systems' users must avoid situations where the Helmet, Power Cord, Battery or face/head cover (Cuff, Shroud, Hood) could become caught up simultaneously with a sudden and strong movement that could cause the Helmet to become dislodged from the users head and result in loss of respiratory protection.
- Materials of HFR Hoods are tested per ASTM F1671 and AATCC 127 to provide an indication of fluid resistance. NIOSH does not conduct this testing as part of their approval.



CAUTION

- When subjected to harsh use in critical environments (e.g. holding and dropping a battery by the power cord) the helmet-battery power cord will wear at a much faster rate than normal. In these types of circumstances, the power cord should be examined prior to each use, and it is recommended to be changed out every 30 days, or sooner if it becomes damaged or degraded.
- Do not operate in environments with temperatures exceeding 54°C
- A suitable environment is when an employee can work a full shift comfortably without any special paraphernalia other than normal clothing.
- Replace damaged or worn Filters immediately.
- Always start with a fully charged battery.
- Charge Li-Ion Battery in a MAXAIR Lithium-Ion battery charger only.
- The Helmet Power Cord should not be removed from its connection to the Helmet unless the Power Cord needs replacement.
- Do not immerse system components in liquid.
- Never use compressed air to clean any part of the MAXAIR System.
- There are no user-serviceable parts inside the Helmet and Li-Ion Battery. Do not attempt to disassemble, open or service the Helmet and Li-Ion Battery. Call Customer Service, 1-800-443-3842, for assistance.

1.3 SYMBOLS – General and Packaging

1		European market “CE” and notified body number “0194”.	18		Catalog Number
2		National Institute for Occupational Safety and Health.	19		NIOSH Number
3		Refer to approval label and User’s instructions for cautions, limitations, and approved assembly configurations.	20		Batch Code
4		High Efficiency.	21		Quantity
5		Use By	22		Order Number
6		Material Fluid Resistance	23		Authorized representative in the European community.
7		Consult instructions for use (IFU)	24		Indoor Use Only
8		Consult User Instructional Manual (UIM) of MAXAIR System	25		Type L and Type R Listing Marks for Canada and the United States
9		Do Not in environments requiring intrinsic safety	26		UL Recognized Component Marks for Canada and the United States.
10		Place of Manufacture	27		European EMC testing to EN60601-1
11		Date of Manufacture	28		Caution, risk of electrical shock. High Voltage.
12		Storage Kept Dry. Keep away from rain.	29		Double insulation
13		Storage Humidity Upper limitation.	30		Recyclable.
14		Storage Temperature limitation.	31		Caution, Warning
15		Battery: Operational Upper limit of temperature.	32		British Standard: Respiratory protective devices- Powered filtering devices incorporating a helmet or a hood.
16		Per Directive 2002/96/EC, product must be collected separately. Do not dispose of as unsorted municipal waste. Contact local distributor for disposal information.	33		Charging
17		Per Directive 2006/66/EC, collect and recycle batteries/ battery packs according to EU Member State regulations.	34		Charge Complete.

2. Regulatory Marking Definitions

Filter markings and colors contain shared and unique information respective to the NIOSH and CE regulatory bodies.



NOTE

Artwork Shown is for Reference Only.

NIOSH (Contents within magenta background): MAXAIR Systems provide HE- High Efficiency Particulate Air Filtering per NIOSH 42 CFR 84.

- "HE" and "NIOSH" are specific terminology for Filter Protection Classifications per NIOSH VFR.
- Purple label background color is specific to NIOSH Filter color coding requirement per ANSI Z88.7-2001.

Contents outside of magenta background: The user should not confuse the markings on a filter relating to any standard other than EN 12941 with the classification of this device when used with the corresponding filter.

- "EN12942, TH2P R S, CE0194" is specific terminology for Filter Protection Classification per EN 12941:1998 + A2 : 2008.
- White label background is specific to CE Filter color coding requirements per EN 12941:1998 + A2 : 2008.



CAUTION

The purchaser/user is responsible for determining the appropriateness of the eCAPR System for each/any of their particular applications/environments.

3. Introduction

3.1 Part Numbers Reference

Catalog Numbers, **REF**, are used in the informational descriptions throughout the User's Instructions; NIOSH Numbers, **P/N**, are shown enclosed in parentheses. Table 1 lists the Catalog Numbers and respective NIOSH Numbers for each component.

Table 1. Part Number Reference Chart

DESCRIPTION	REF	P/N
HELMETS		
eCAPR (turnlock w/Cage, Hard Hat Liner)	2079-03	03531214 Blower Assy. 03531148 Liner 01031269 Cage 2590-05 Power Cord
POWER CORDS		
POWER CORD (Turnlock)	2590-05	2590-05
POWER CORD (Turnlock)	2590-08	00722184
LINERS		
LINER	2071-07	03531148
COVERS		
FCC (Filter Cover Cap)	2061-08	01031284
HARD HAT	2061-04A	01031528
CAGE	2051-07	01031269
FILTERS		
FILTER CARTRIDGE (XP)	2167-10	01031569
PRE FILTER	2172-97	03731006
LENSES		
LENS (ANSI Z87)	2400-090L	03521128
CUFFS		
DLC LENS CUFF, MEDIUM LARGE	2365-02ML	01031291
DLC LENS CUFF, SMALL MEDIUM	2365-02SM	01031316
DLC LENS CUFF, MEDIUM LARGE	2366-02ML	01031555
DLC LENS CUFF, SMALL MEDIUM	2366-02SM	01031556
SHROUDS		
DLC-SHROUD, MEDIUM LARGE	2260-05ML	01031434
DLC-SHROUD, SMALL MEDIUM	2260-05SM	01031435
DLC-SHROUD, MEDIUM LARGE	2264-01ML	01031565
DLC-SHROUD, SMALL MEDIUM	2264-01SM	01031562
HOODS		
DLC-HOOD, MEDIUM LARGE	2271PS-07ML	07831245
DLC-HOOD, SMALL MEDIUM	2271PS-07SM	07831244



Table 1. Part Number Reference Chart, cont'd

DESCRIPTION	REF	P/N
BATTERIES		
LITHIUM ION BATTERY	2500-36TSC	01532104
LITHIUM ION BATTERY	2500-37TSC	01532161
LITHIUM ION BATTERY	2500-30TSC	01532116
BELT		
BATTERY BELT	2000-76	2000-76
CHARGERS		
SINGLE CHARGER	2600-01	01432089
SINGLE CHARGER	2600-02	01432202
6-GANG CHARGER	2602-06	
6 GANG CHARGER BRACKET	2602-06B	



3.2 Approved System Configuration Components

Refer to the regulatory approval inserts shipped with your systems, and the following NIOSH website addresses for MAXAIR eCAPR regulatory approval status.

http://www2a.cdc.gov/drds/cel/cel_results.asp?startrecord=1&Search=cel_form&maxrecords=50&manufacturer=BMD&appdatefrom=&appdate to=&powered=&scbatype=&scbause=&privatelabel=

http://www.cdc.gov/niosh/npptl/topics/respirators/disp_part/PAPRtables.html

Table 2. summarizes current components that may be used to configure systems relative to the applicable Approval Body.

Table 2. Approved System Components

Catalog Number, REF (NIOSH Number, P/N)	Description	Filter Cartridge 2167-10 XP (01031569)	Pre Filter 2172-97 (03731006)	NIOSH
2079-03 (P/Ns 03531214, 03531148, 01031269, 2590-05)	Helmet with Cage and Liner	✓ w/o Cage	✓ w/Cage	✓
2590-05 (2590-05)	Power Cord	✓	✓	
2590-08 (00722184)	Power Cord	✓	✓	
2071-07 (03531148)	Helmet Liner	✓	✓	✓
2061-08 (01031284)	Filter Cover Cap (FCC)	✓		✓
2061-04A (01031528)	Hard Hat	✓		✓
2051-07	Cage (Filter Frame)		✓	✓
2271PS-07ML	DLC Hood, Medium-Large		✓	✓
2271PS-07SM	DLC Hood, Small-Medium		✓	
2400-090L (03521128)	Impact Lens	✓		✓
2365-02ML (01031291)	DLC Lens-Cuff, Medium-Large	✓		
2365-02SM (01031316)	DLC Lens-Cuff, Small-Medium	✓		
2366-02ML (01031555)	DLC Lens-Cuff, Medium-Large	✓		✓
2366-02SM (01031556)	DLC Lens-Cuff, Small-Medium	✓		✓
2260-05ML (01031434)	DLC Shroud, Medium-Large	✓		
2260-05 (01031435)	DLC Shroud, Small-Medium	✓		
2264-01ML (01031565)	DLC Shroud, Medium-Large	✓		✓
2264-01SM (01031562)	DLC Shroud, Small-Medium	✓		✓
2000-76	Battery Belt	✓	✓	✓
2600-01 (01432089)	Li-Ion Battery Charger	✓	✓	✓
2600-02 (01432202)	Li-Ion Battery Charger	✓	✓	✓
BATTERY CHOICES PER FILTER CHOICE				
2500-36TSC (01532104)	Li-Ion Battery (4-10 HR/CHARGE)	✓	✓	✓
2500-37TSC (01532161)	Li-Ion Battery (6-15 HR/CHARGE)	✓	✓	✓
2500-30TSC (01532116)	Li-Ion Battery (8-20 HR/CHARGE)	✓	✓	✓

**NOTE**

Use of Gang Charger and Bracket do not require NIOSH approval or CE Mark and are appropriate for use with all System Configurations.

2602-06	6-Gang Charger, w/6 2600-02 Chargers
2602-06B	6-Gang Charger Bracket, for 2600-02 Chargers

3.3 eCAPR Systems

3.3.1 Systems and System Components

Systems are configured from four main components, a Helmet, a Battery, a Battery Belt, and a Battery Charger.

- One Belt and one Charger are common to all systems.
- Two Battery choices are most common, including -
 - 2500-36TSC - typically 4-10 hours/charge
 - 2500-37TSC - typically 6-15 hours/charge
- One 2079-03 Helmet System

Table 3. SYSTEMS and their COMPONENTS

eCAPR-36			
ITEM	REF	P/N	COMPONENTS
1	2079-03	03531214 Blower Assembly 03531148 Liner 01031269 Cage 2590-05 Power Cord	Helmet Assembly
2	2500-36TSC	01532104	Li-Ion Battery
3	2000-76	2000-76	Battery Belt
4	2600-02*	01432202	Li-Ion Battery Charger
eCAPR-37			
ITEM	REF	P/N	COMPONENTS
1	2079-03	03531214 Blower Assembly 03531148 Liner 01031269 Cage 2590-05 Power Cord	Helmet Assembly
2	2500-37TSC	01532161	Li-Ion Battery
3	2000-76	2000-76	Battery Belt
4	2600-02*	01432202	Li-Ion Battery Charger

* The alternate 2600-01 Single Charger may be substituted in place of the 2600-01.

3.3.2 Systems Configuration Possibilities (Trees)

eCAPR Cuff, Shroud, and Hood System Configurations Quick Setup Guide

eCAPR-36 (with 2500-36TSC Battery) OR eCAPR-37 (with 2500-37TSC Battery)

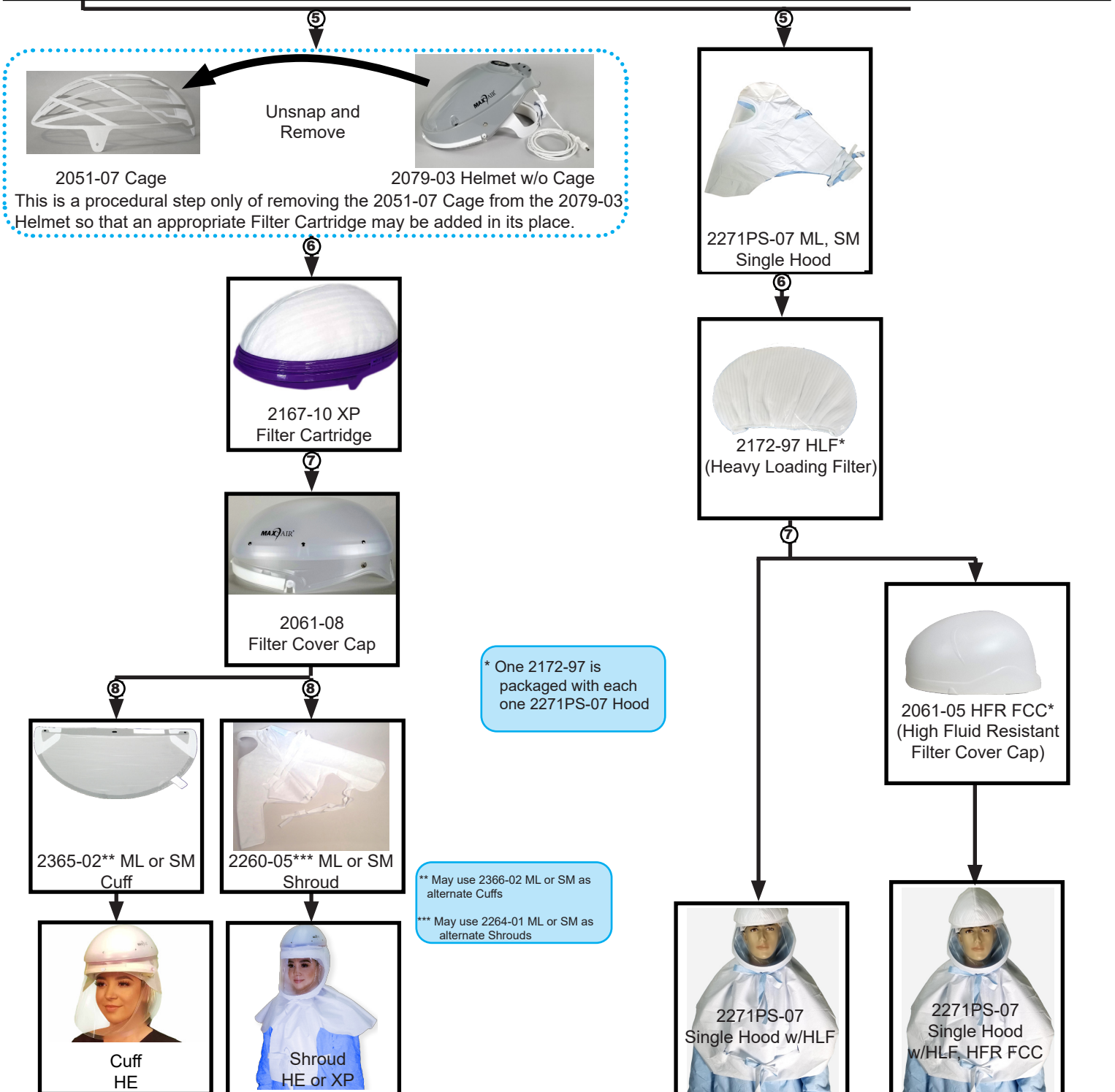
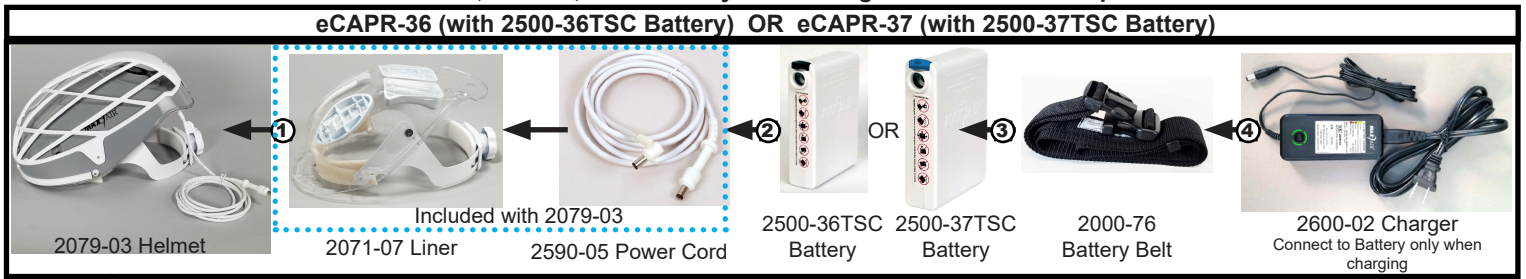

eCAPR Hard Hat System Configurations Quick Setup Guide

eCAPR-36HH (with 2500-36TSC Battery) OR eCAPR-37HH (with 2500-37TSC Battery)

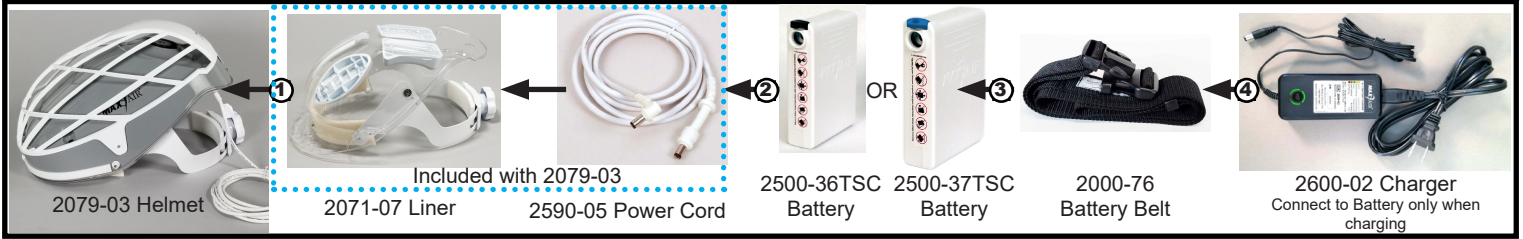

This is a procedural step only of removing the 2051-07 Cage from the 2079-03 Helmet so that an appropriate Filter Cartridge may be added in its place.

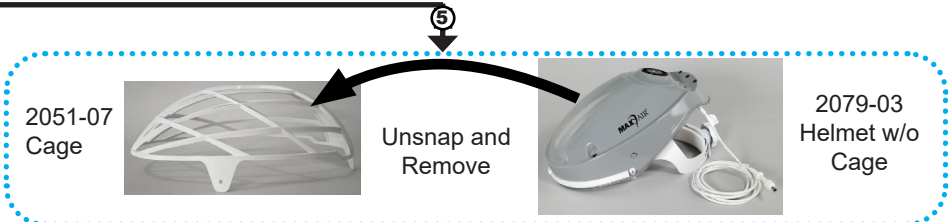

3.4 Standard System Components and Order and Part Numbers

The MAXAIR® Systems eCAPR Systems are multi-application air-purifying, Li-Ion Battery powered particulate respirators that optimize user safety, convenience, ease-of-use, and cost effectiveness.

The eCAPR loose fitting Powered Air Purifying Respirator (PAPR) System configurations are for filtering aerosolized and droplet particulates from otherwise breathable air.



ITEM	REF	P/N	DESCRIPTION
1	2079-03 ^A	03531214 03531021 ^A 01031269 ^{A,B} 2590-05 ^A	Helmet Assembly, consisting of - 1a - Helmet 1b - 2071-07 Liner 1c - 2051-07 Cage 1d - 2590-05 Power Cord
2	2500-36TSC ^C	01532104	Li-Ion Battery
3	2000-76	2000-76	Battery Belt
4	2600-02 ^D	01432202	Li-Ion Battery Charger

A Each 2079-03 Helmet includes a 2071-07 Helmet Liner, 2051-07 Cage, and 2590-05 Power Cord assembled to the helmet.

B The Cage provides shipping protection. For Shroud and Cuff configurations the Cage is removed and replaced with an appropriate Filter Cartridge.

C The 2500-37TSC and 2500-30TSC are alternate Batteries.

D The 2600-01 is an alternate Charger.

3.5 Helmets

3.5.1 2079-03 (03531214, 03531021, 01031269,2590-05) Helmet - Common Helmet And Liner Characteristics

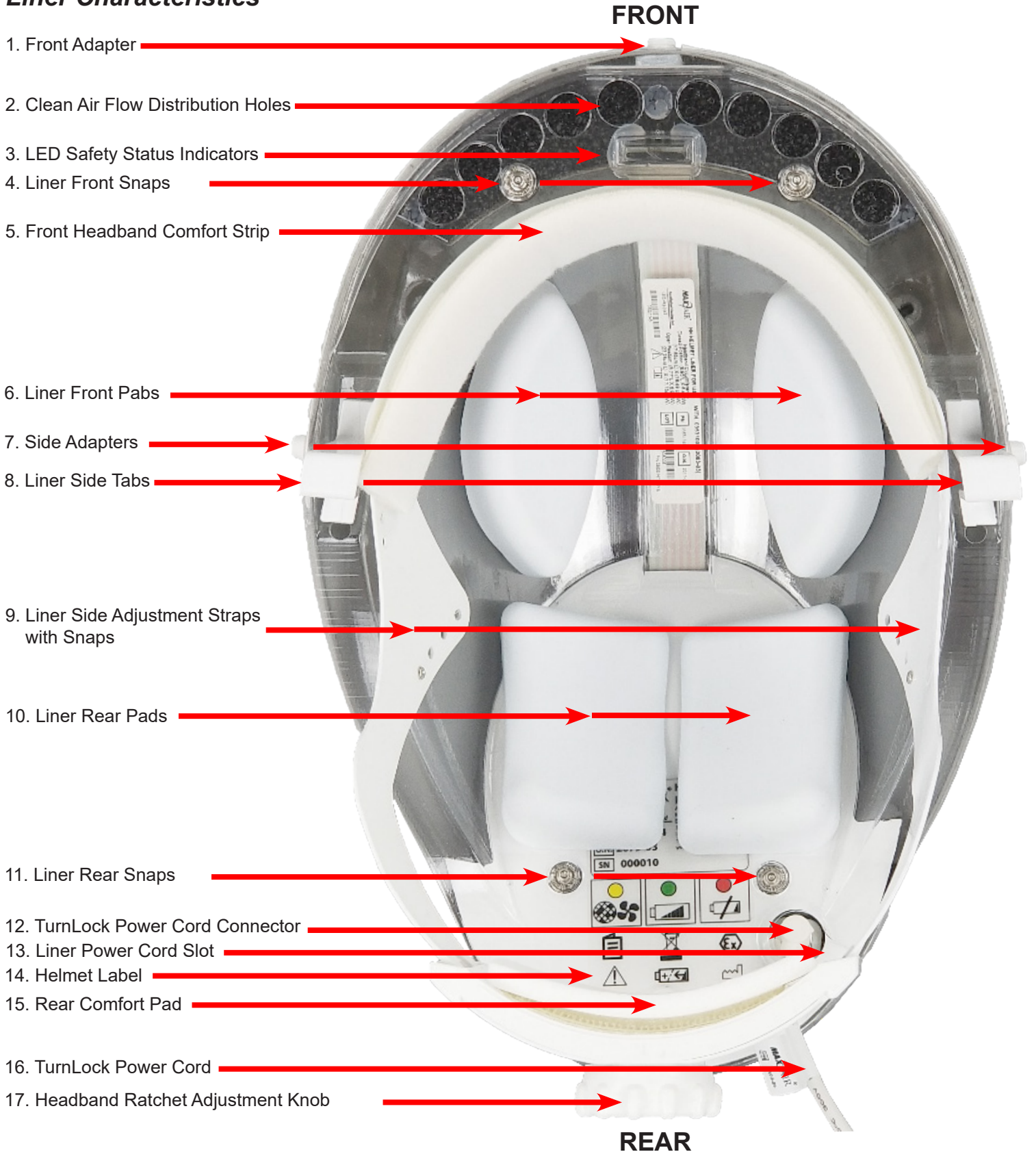

3.5.2 2079-03 Helmet with SnapOn Cage



03531214 Blower Assembly (Helmet)
2051-07 Filter Frame (Cage)
2071-03 Liner
2590-05 Power Cord

with Cage Removed



3.5.3 Characteristics Details (Refer to page 18)

1 Front Helmet Adapter - Attachment point for assembly of disposable face and head covers.

2 Clean Air Flow Distribution Holes - 10 air vents bringing filtered air to the user.

3 LED Safety Status Indicators



WARNING

Failure to heed the LED Safety Status Indicators and exit immediately to a safe environment when alarm conditions are present may be hazardous to the user's health. When Green LEDs are not lighted, the user should immediately exit to a safe area to obtain a recharged Battery.

- The eCAPR Helmet has five LED Safety Status Indicators located on its underside front that are always visible in the user's peripheral vision. They alert the user to the safe operating conditions of the system. They will provide an early warning alert to the user when the eCAPR Helmet is no longer able to maintain adequate airflow and/or Battery charge to provide adequate or continuing protection for the user.
- There are five LED Safety Status Indicators, one yellow, three green, and one red. On start-up, all LED's should come on briefly (LED test) before proceeding to normal operation. During normal operation, the LEDs continuously indicate the status of the Airflow and Battery charge level.
- Airflow is proper if the Yellow LED is off. A continuously lit or flickering Yellow LED indicates low or marginal airflow. If the Yellow LED is lit, check the Filter Cartridge for excess particulate/dirt build-up and damage, and replace if necessary.
- The Battery charge level is indicated by the three Green and one Red LEDs. The approximate charge level is continuously indicated by the changing LEDs.

CONDITION	DESCRIPTION	YELLOW	GREEN 3	GREEN 2	GREEN 1	RED
1	Battery charge OK, 75% to 100%, Airflow OK		✓	✓	✓	
2	Battery charge OK, 50% to 75%, Airflow OK			✓	✓	
3	Battery charge OK, 25% to 50%, Airflow OK				✓	
4	Battery charge LOW, 0% to 25%, Airflow OK					✓
5	Airflow LOW, Battery charge LOW	✓				✓
6	Airflow LOW, Battery charge OK, 75% to 100%	✓	✓	✓	✓	
7	Airflow LOW, Battery charge OK, 50% to 75%	✓		✓	✓	
8	Airflow LOW, Battery charge OK, 0% to 50%	✓			✓	

- When all three Green LEDs are lit, the Battery has approximately 75% to 100% of its charge.
- When two Green LEDs are lit, the Battery has approximately 50% to 75% of its charge.
- When only one Green LED is lit, the Battery has approximately 25% to 50% of its charge. When this occurs the user should prepare to exit to a safe area to obtain a fully charged Battery.
- When all three Green LEDs are off and the Red LED is lit, the Battery level is low, with approximately 0% to 25% charge left. When this occurs the user should promptly exit to a safe area to obtain a fully charged Battery.
- If the Battery did not provide 4-10 hours of use, change to a fully charged Battery or recharge the current Battery. (The 2500-37TSC Battery can provide as much as 12-15 of use per charge).

4 Front snaps for Liner - Front mounting of Liner to Helmet

5 Front Headband Comfort Strip - Provides cushion for comfort. Attached via Velcro, and removable. For replacement refer to Sections 7 and 21, Accessories.

6 Front Liner Pads - Provide cushion for comfort. Attached via adhesive. For replacement refer to Accessories, Section 21.

7 Side Adapters - Attachment points for assembly of disposable face and head covers.

8 Liner Side Tabs - Part of air sealing system. Easily replaced.

9 Side Adjustment Straps with Snaps - Height adjustment. Four holes represent four possible height adjustments to accommodate different head sizes and ensure convenient viewing of the LED Safety Status Indicators. Secure into desired position by snapping against post/stud. Both sides are to be in the same hole position.

10 Liner Rear Pads - Provide cushion for comfort. Attached via adhesive. For replacement refer to Section 22, Accessories.

11 Rear snaps for Liner - For mounting Liner to Helmet

12 TurnLock Power Cord Connector - Easy and secure attachment and removal of Power Cord to/from Helmet.

13 Liner Power Cord Slot - Allows removal and attachment of Liner without removing Power Cord

14 Helmet Label - P/N, REF, and SN identification. Refer to symbol definition chart for further details.

15 Rear Headband Comfort Pad - Provides cushion for comfort and sizing for very small head sizes. Attached via Hook and Loop, and removable. For replacement, refer to Section 22.

16 TurnLock Power Cord - Powers Helmet from the Battery. For replacement, refer to Section 22, Helmets and Helmet Accessories.

17 Headband Ratchet Adjustment Knob - Head circumference adjustment knob.

3.5.4 Helmet Symbol Definitions

These symbols are located on the Helmet and are defined as follows:

	Yellow safety LED = Low airflow, check filter and replace if necessary.		Use with rechargeable Li-Ion batteries only.
	Green safety LEDs = battery level.		Do Not Use in environments requiring intrinsic safety
	Red safety LED = low battery.		

3.6 2366-02SM/ML (01031291, 01031316) Overview

Identify, familiarize and understand the following key items.

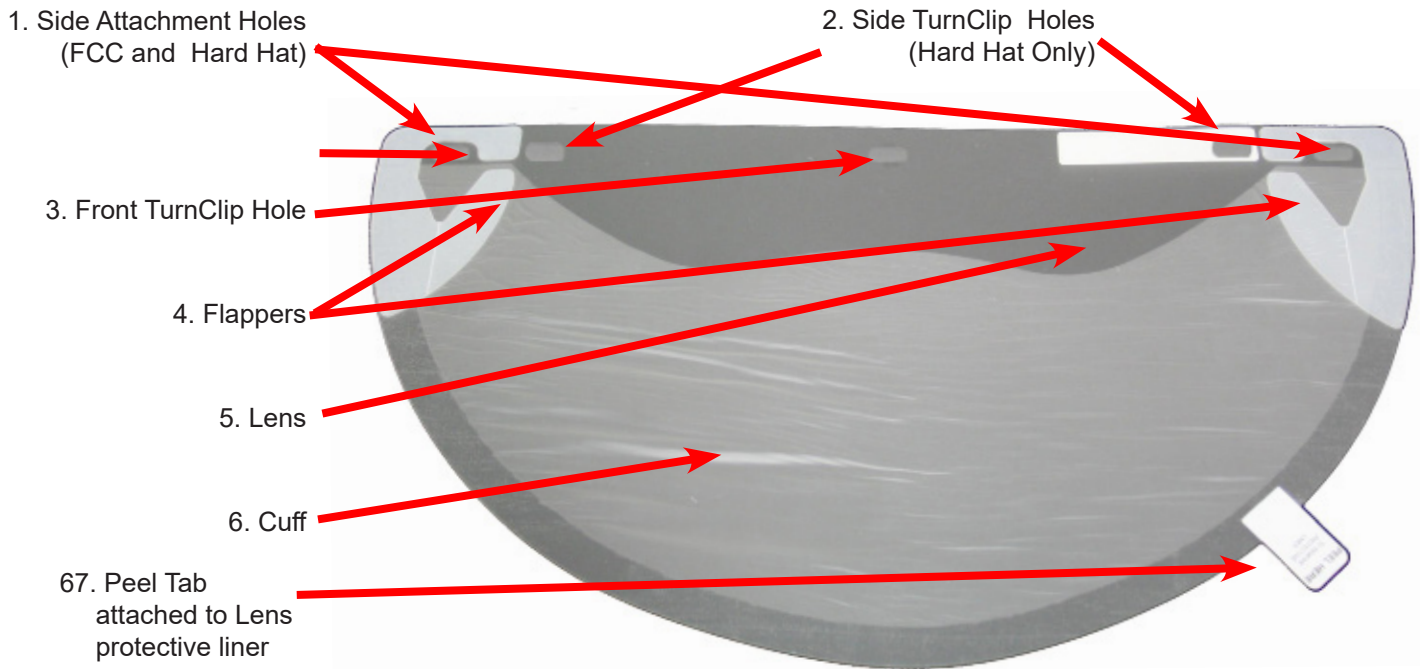

#	Characteristics
1	Mounts to the FCC Side Post Adapters.
2	Mounts to the Hard Hat Side TurnClips.
3	Mounts to the Helmet FCC/Hard Hat Front TurnClip.
4	Rest against Helmet Liner Side Foam. Act as side air deflectors that channel air away from the ears.
5	Transparent for visibility. Lens is on the front, outside of the DLC.
6	Facial conforming seal, from one temple, down under the chin, and up to other temple. Cuff is on the back, inside of the DLC.
7	To facilitate Len's protective liner removal.

3.7 Battery, Belt, and Charger Overview









#	Characteristics
1	Attaches to Adjustable Belt or clothing
2	Socket for Helmet's Power Cord or Charger's Battery Plug.
3	Releases the Power Cord Connector for removal
4	Wraps around waist. Battery is attached to belt via the belt clip.
5	Secures belt to the waist.
6	Charging status indicator for Li-Ion Battery. Red= Charging Green= Charge Complete
7	Plugs into Li-Ion Battery socket.

Battery and Charger Symbol Definitions

These symbols are located on the device and are defined as follows

Battery

	Rechargeable. For use only with MAXAIR Li-Ion Batteries		Do not attempt to disassemble, open, or service.
	Do not place near or in a flame.		Do not drop.
	Do not immerse in liquid.		Do not puncture.

Charger

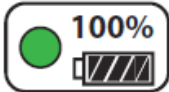
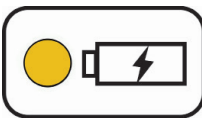
	Charger's Green LED light, Charge Completed.		Charger's Orange LED light, Charging
--	---	---	---

4. Unpacking Standard System Components and Parts Identification

4.1 Unpacking the eCAPR Helmet - 2079-03 (03531214, 03531021, 01031269, 2590-05) eCAPR Helmet

Carefully unpack the 2079-03 MAXAIR eCAPR Helmet from the shipping box. (Verify there are no missing or loose components and that the helmet shows no signs of physical damage. Assemble the Helmet into the desired configuration and verify that it is fully functional. Report any damage to the shipper immediately for resolution.

Contact Customer service 1-800-443-3842, if you have questions.

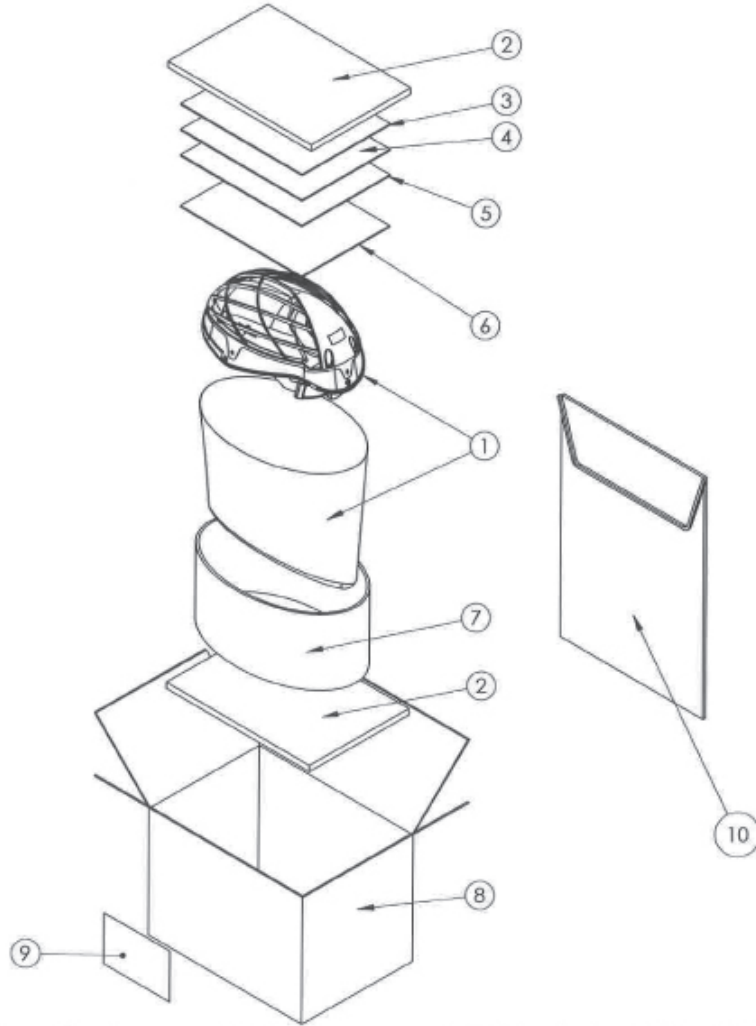

Item No.	Part No.	Description	Qty
1	03531244 NIOSH P/N 03531214	MAXAIR Helmet, E-CAPR	1
2	03523060	Foam Pad, 9 x 12	2
3	03521080	Symbol Definition Chart	1
4	03523241	User Instruction Manual (UIM)	1
5	03523263	Quick Set-up Guide	1
6	03531233RFL	207X-03 Respirators NIOSH Approved Matrix	1
7	03523054	Single Face Corrugated Pad	3 ft.
8	03521053	Box 13 x 9 x 7	1
9	03533243	Box Label	1-
10	03531097	Bouffant Shower Cap Assy.	1

4.2 Unpacking the 2167-10 (01031569) Filter Cartridge

Carefully unpack the 2167-10 Filter Cartridges from the shipping box. Verify there are no missing or loose components and that the Filter Cartridges show no signs of physical damage. Assemble one Filter Cartridge to a eCAPR Helmet with Liner and Power Cord already assembled for Cuff and Shroud configurations.

Contact Customer service 1-800-443-3842, if you have questions.

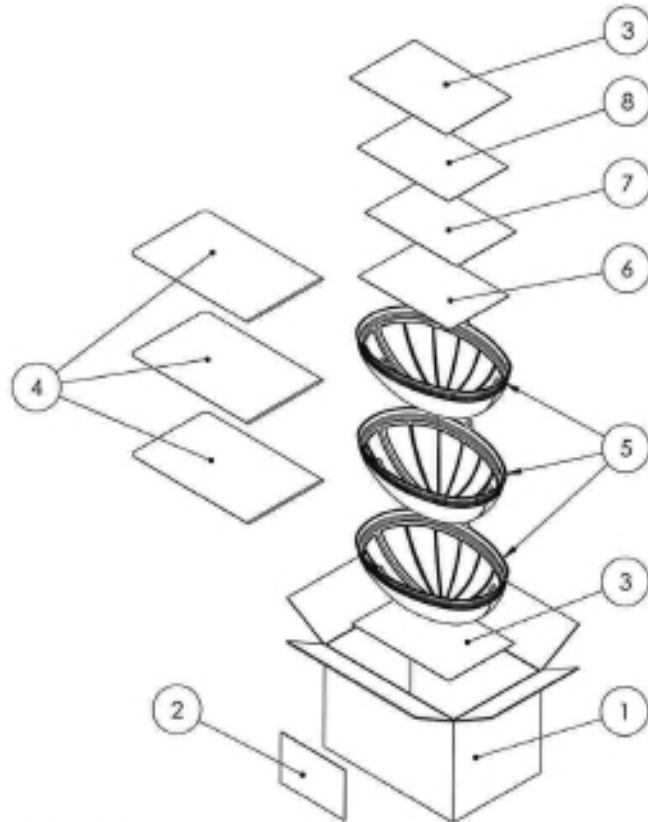

ITEM NO.	PART NUMBER	DESCRIPTION	QTY.
1	01023343	BOX, 12' x 8' x 8"	1
2	01033574	LABEL BOX 2167-10, 4" X 6"	1
3	01023344	PAD, 6" x 9"	2
4	01021342	RECLOSABLE BAG, FILTER CARTRIDGE	3
5	01031570/ 01031569 NIOSH	XP-HH Filter Cartridge	3
6	03531051FFL	LABEL FILTER, NIOSH APPROVED	1
7	01021347	IFU, 8.5 x 5.5 GENERAL	1
8	03521080	SYMBOL DEFINITION CHART	1

4.3 Unpacking the 2061-08 (01031284) Filter Cover Cap (FCC)

Carefully unpack the 2061-08 Filter Cover Cap from the shipping box. Verify there are no missing or loose components and that the FCC show no signs of physical damage. Connect the Filter Cover Cap to a eCAPR Helmet with Filter Cartridge, Liner, and Power Cord already assembled for Cuff and Shroud configurations.

Contact Customer service 1-800-443-3842, if you have questions.

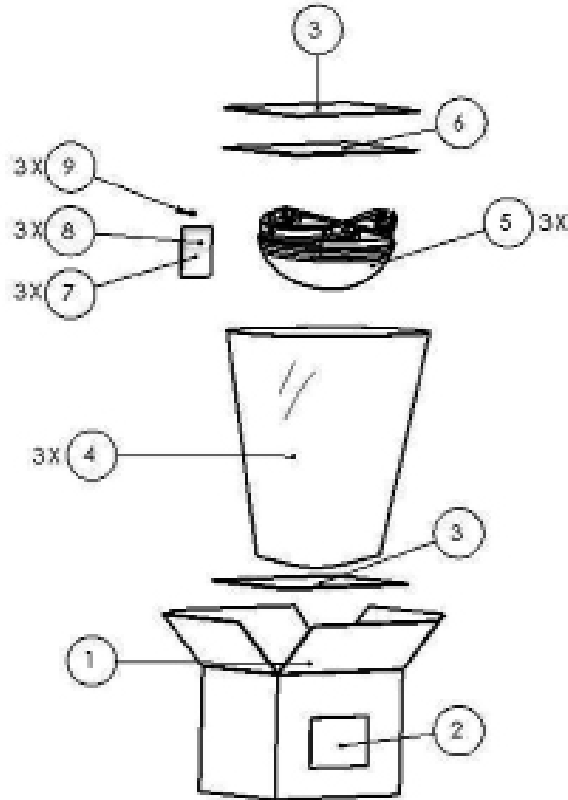

Item	Part Number	Part Name	Material	QTY.
1	01023348	Box, Final Packaging, Filter Cover Cap	Paper/Box	1
2	01033350	Label Box, Filter Cover Cap	Paper/Adhesive	1
3	01023349	Corrugated Pad, Filter Cover Cap	Paper/Pad	2
4	P900037	bag 18" x 24" .002 ML	Plastic	3
5	01031529 01031284 - NIOSH/	Assy. Filter Cover Cap	Plastic	3
6	01023360	IFU, DLC, Filter Cover Cap	Paper	1
7	02021001	Ziplock bag	Plastic	3
8	01021533	Front Lens Mount/ Vent Cap Insert	Paper	3
9	01021595/ 01021596	Front Lens Mount/ Vent Cap	Plastic	3

4.4 Unpacking the 2500-36TSC (01532105) Battery

Carefully unpack the 2500-36TSC Battery from the shipping box. Verify there are no missing or loose components and that the Battery show no signs of physical damage. Connect the Battery to a fully assembled eCAPR Helmet with Filter Cartridge and Filter Cover Cap or Hard Hat to verify that it powers the Helmet and that at least one Green LED lights. Report any damage or non-function to the shipper immediately for resolution.

The 2500-36TSC Battery is packaged similarly.

Contact Customer service 1-800-443-3842, if you have questions.

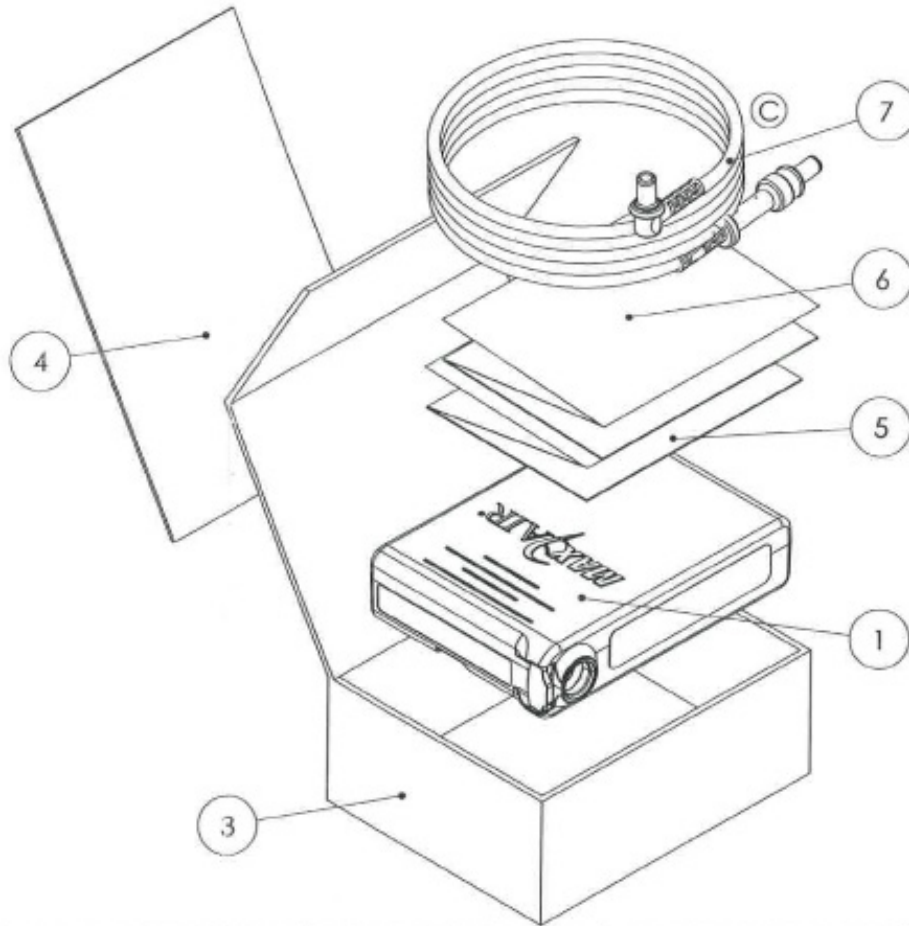

Part List				
ITEM NO.	Part Number	Part Name	Material	QTY.
1	01532104	LI-ION Battery	-	1
2	00011340	Buble Wrap, 12" x 300 ft	Plastic	0.003 ROLL
3	02523090	Box	Cardboard	1
4	01523115	Box Label	Adhesive Label	1
5	01523128	Instructions Sheet	Paper	1
6	03521080	Maxair CAPR System Symbol Definition Chart	Paper	1
7	2590-05	Power Cord	Plastic/Wire	1

4.5 Unpacking the 2000-76 Battery Belt

Carefully unpack the 2000-76 Battery Belt from the shipping bag. Verify there are no missing or loose components and that the Belt shows no signs of physical damage. Report any damage or non-function to the shipper immediately for resolution.

Contact Customer service 1-800-443-3842, if you have questions.

Part List					
Item	Dwg. No.	Dwg. Title	Material	Fit/Function	QTY.
1	2000-76	Lithium-Ion Battery Belt Assembly	N/A	Battery Holder	1
2	00721160	Dual Body	Polycetal	-	1
3	00721143	Belt, Latch	Polycetal	-	1
4	P040003	Plastic Webbing	Plastic	-	76-1/2"
5	00723150	Label, Part Number	Label/Adhesive	Informative, Part Number Location	1
6	00721144	Belt Holder	Polycetal	Belt Holder	1

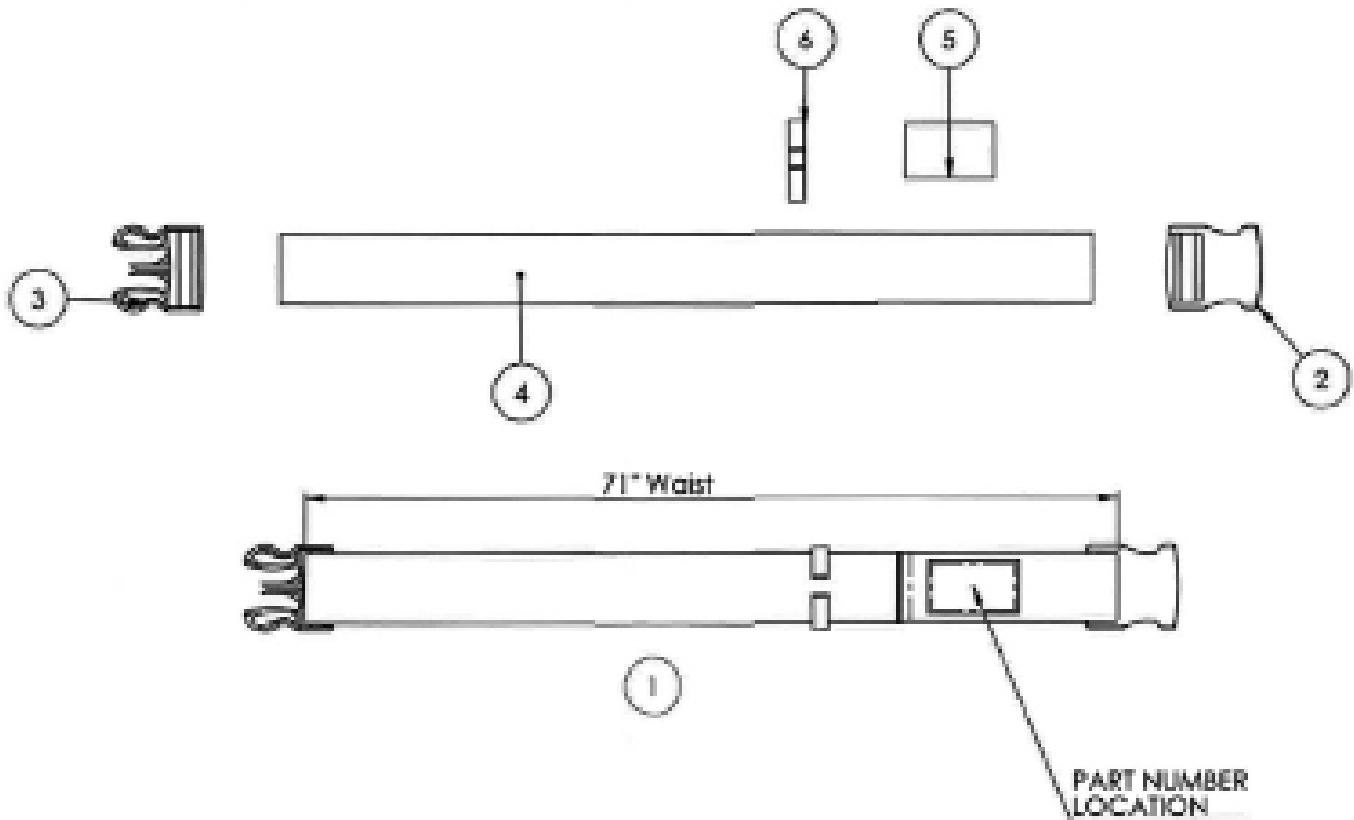

4.6 Unpacking the 2600-02 (01432202) Battery Charger

Carefully unpack the 2600-02 Battery Charger from the shipping box. Verify there are no missing or loose components and that the Charger shows no signs of physical damage. Connect the Charger to a working wall outlet and verify that the Green LED is lit. Connect the Charger to a Battery that powers a MAXAIR Helmet with either a red LED or one or two Green LEDs lit, and verify that when that Battery is connected to the Charger, the Charger LED turns from Green to Red to indicate that it is charging the Battery. Report any damage or non-function to the shipper immediately for resolution.

Contact Customer service 1-800-443-3842, if you have questions.

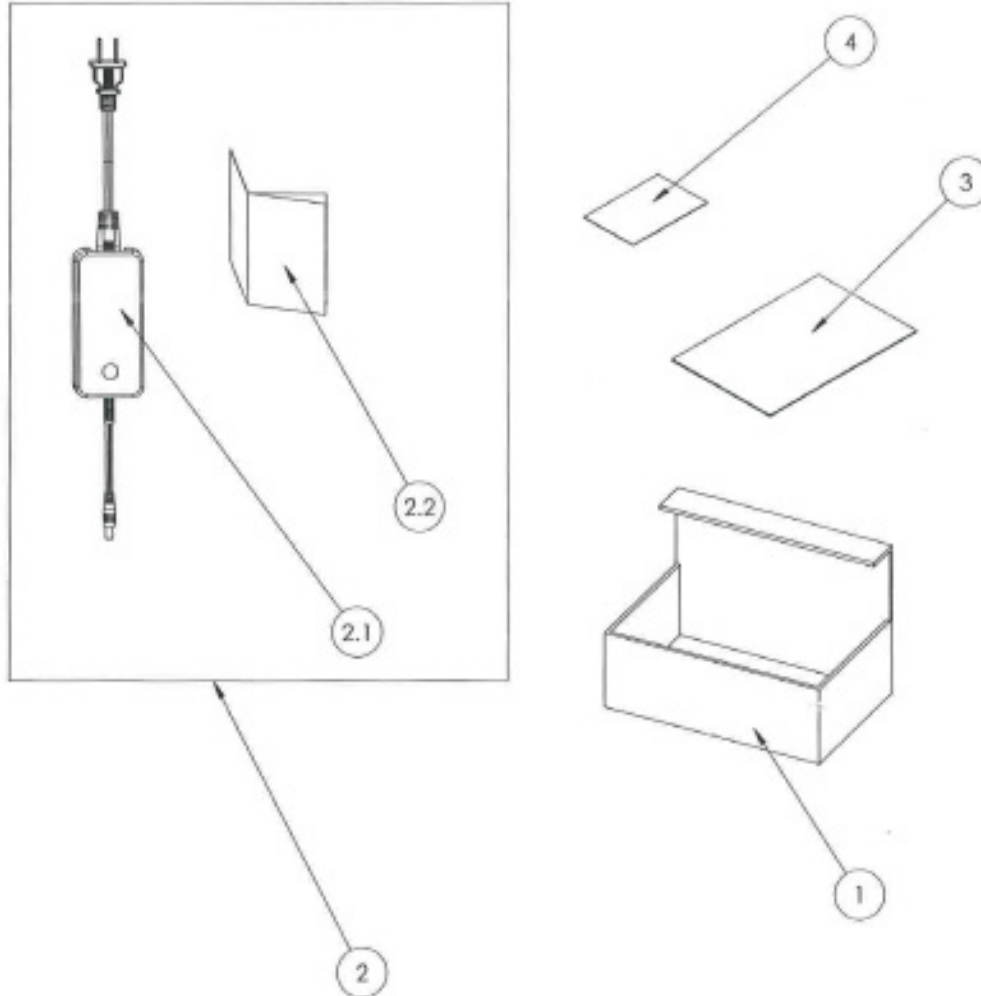

Item #	P/N	Description	Material	Fit / Function
1	P900127	Box, Shipping	Cardboard	Packaging
2	01432206	Charger	Electronics/ ABS housing	Charging Battery
2.1	01432202	Charger (NIOSH)		
2.2	01423205	Product Specification Sheet	Paper	Labeling
3	01433207	Label, shipping	Paper/Adhesive	Labeling
4	03521080	Symbol Definition Chart	Paper	Labeling

4.7 Unpacking the DLC (Disposable Lens Cuff) - 2366-02SM (0103156) and 2366-02ML (0103155)

The 2366-02 ML & SM Cuffs are packaged similarly.



Carefully inspect the DLC boxes to ensure there is no physical damage to the boxes and contents. Report any damage to the shipper immediately for resolution.

Contact Customer service 1-800-443-3842, if you have questions.



NOTE

DLC Boxes are 2 sizes, Long (placed on bottom) for the larger 2366-02ML, and Short (placed on top) for the smaller 2366-02SM. Stack as shown for easy dispensing.



1. Open the dispensing end by grasping the box end with your left hand as shown and push through the top curved perforation line.



2. Pull the top-end piece off and away from the box.



3. Brace the right-side end piece with your right hand. Pull the left-side end piece along its perforation line, tearing downward.



4. Pull the left-side end piece down and off the box.



5. Lift the box a few inches with your right hand. Tear off the small bottom-end piece at its perforation line.



6. When finished, the dispensing box should be as shown above.



7. To Dispense, merely reach in and grasp the end of the top DLC and pull slightly up and out.



8. Position a SM DLC box on top of a ML DLC box as indicated above.



9. Dispensing DLCs from the top or bottom box is easy and prompt.

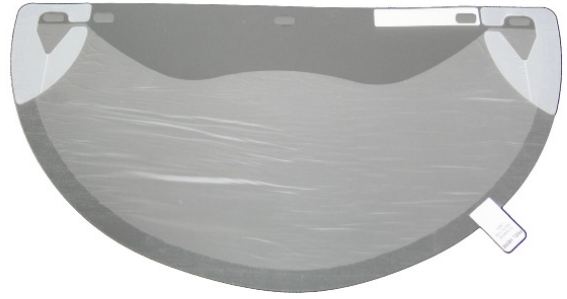

ITEM	CATALOG NUMBER	NIOSH NUMBER	QTY(EA)	DESCRIPTION
1	2366-02SM	0103156	40	DLC (Disposable Lens-Cuff) Small/Medium
2	2366-02ML	0103155	40	DLC (Disposable Lens-Cuff) Medium/Large

5. Standard System Set Up

5.1 Components Check List

Required Components				
ITEM	REF	P/N	QTY	DESCRIPTION
1	2079-03	03531214, 03531021, 01031269, 2590-05	1ea	MAXAIR eCAPR Helmet Assembly
2	2366-02SM or 2366-02ML	0103156 OR 0103155	40/ Box	Disposable Lens Cuff (DLC) - Small/ Medium (SM) or Medium/ Large (ML)
3	2500-37TSC	01532161	1ea	Li-Ion Battery
4	2600-01	01432089	1ea	Li-Ion Battery Charger
5	2000-76	2000-76	1ea	Battery Belt

5.2 Setting Up

1. Check the position of the Headband Comfort Strips. (See Section 7 for Comfort Strip assembly and replacement instructions).
2. Adjust the Rear Headband Ratchet Adjustment Knob counterclockwise to expand the Headband circumference to ensure the Helmet will fit easily before donning. (See Section 6 on Donning for more detail.)
3. Adjust the Height Adjustment Snaps on the Helmet Liner to ensure proper and secure fit of the eCAPR System on the head and good visibility of the Safety Status Indicator LEDs. (See Section 6 for more detail.)
4. Check to ensure that the Helmet Power Cord is firmly attached to the Helmet Power Cord Connector.





5.3 Assemble and Disassemble Components



CAUTION

Prior to operation, review all components' Instructions For Use regarding set-up, assembly/disassembly, and don/doff in sections 6,10-21.

The general assembly/disassembly steps are as follows:

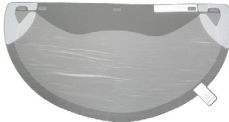
STEP	ASSEMBLE			STEP	DISASSEMBLE
4	Assemble the 2061-08 Filter Cover Cap to the Helmet. (Alternate Covers are appropriate for other configurations.)			2	If required, disassemble the 2061-08 Filter Cover Cap from the Helmet.
3	Snap off the 2051-07 SnapOn Cage and snap on the 2167-10 Filter Cartridge from the Helmet.			3	If required, disassemble the 2167-10 Filter Cartridge from the Helmet. (Dispose appropriately as hazardous waste.)
1	Inspect and ready the 2078-03 Helmet for use.			5	If required, prep the 2079-03 Helmet for storage.
2	If required, assemble the 2071-07 Helmet Liner to the Helmet.			4	If required, disassemble the 2071-07 Helmet Liner to the Helmet.
5	Assemble the DLC to Helmet. (Alternate Face/Head covers may be used for other configurations.)			1	Disassemble the DLC. (Dispose of the DLC appropriately as hazardous waste.)

5.4 Inspections

**NOTE**

If you have difficulty with the proper operation of a MAXAIR System, first check for any visible damage to the outer and inner surfaces of the helmet, and any damage to the attached helmet power cord and the battery.

Prior to each use, if any of the following issues are discovered for any system component(s), replace the particular item(s) by following the assembly/disassembly procedures for the particular item(s).

- Tears or Breaks.
- Contamination from blood or other bodily fluids not safely removed by following approved disinfection procedures.
- Compromise between the DLC (or alternate face seal) and FCC (or helmet) seal.
- Damage or distortion to the filter cartridge gasket.
- Filter is soiled or loaded (clogged) with particulate such as to compromise its performance or cause the yellow LED to be lighted.
- Compromise between the filter cartridge and helmet seal.
- Any other threat to proper function.

MAXAIR Systems are very reliable, essentially sealed helmet systems that do not require periodic maintenance. With careful and recommended use and adherence to all cautions, all components are expected to provide reliable service for their full useful life.

5.5 Warning Device: Yellow LED Air Flow Indicator Check - Bouffant Shower Cap Method

**CAUTION**

Prior to donning the system, the Safety Status Yellow LED function can and should be checked prior to use. The yellow LED indicates that the respirator is no longer able to maintain adequate airflow for protection of the user

**CAUTION**

In preparation for the following test,

1. Ensure the Bouffant Shower Cap is in good condition with no holes or tears.
2. Ready the Helmet for test with a Filter Cartridge and Filter Cover Cap attached, and without any Cuff, Shroud, or Double Shroud attached.



1. Place the Bouffant Shower Cap over the Helmet, all the way around, from top to bottom.



NOTE

Ensure the Bouffant Shower Cap is completely below the bottom edge of the Filter Cover Cap (this is the area of air intake that needs to be blocked off).



2. Connect the Helmet Power Cord to a known charged Battery (at least 2 Green LEDs light when connected to a Helmet). Push the Power Cord Connector into the Battery Receptacle until the Secure Connection audibly clicks.



3. On power-up all five LEDs will be lit for 5-10 seconds.



4. Allow the Helmet to compensate until the Yellow LED turns on (5-45 seconds).



4. As soon as the Yellow LED turns on - **in less than five seconds** - open the Bouffant Shower Cap approximately 1" to 2" (3 cm to 5 cm). Notice the Yellow LED turns off. Leave the Bouffant Shower Cap open.



CAUTION

Do not allow the Yellow LED to be on more than ten seconds.

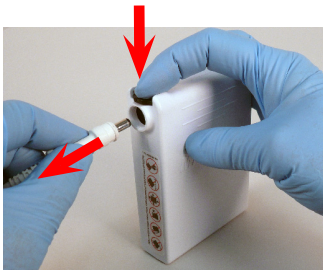

5. Disconnect the Helmet Power Cord from the Battery - push the Secure Connection Button down, pull Cord Connector out, release the Button.



CAUTION

Ensure the Power Cord is disconnected from the battery before performing step 6.



6. Remove the Bouffant Shower Cap completely from the Helmet.

5.6 Warning Device: Yellow LED Air Flow Indicator Check - Tape Method



CAUTION

Prior to donning the system, the Safety Status Yellow LED function can and should be checked prior to use. The yellow LED indicates that the respirator is no longer able to maintain adequate airflow for protection of the user

Start taping here



Air Inlet Channel



1. Start taping approximately one inch away from the front-center of the Helmet. (One inch to the side of the front TurnClip.

2. Tape over the Air Inlet Channel all the way around the Filter Cover Cap (FCC).

3. Cut the tape end so that it will be long enough to overlap the beginning to ensure you can cover all the Air Inlet Channel.



4. Leave the tape end off the Air Inlet Channel about six inches from the front-center of the Helmet, leaving about a 6-7 inch open gap.

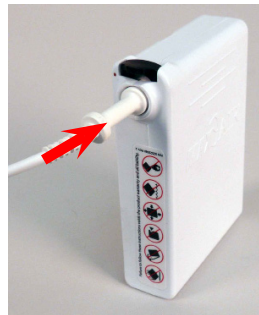

5. Connect the Helmet Power Cord to the Battery. Push the Power Cord Connector into the Battery Receptacle until the Secure Connection audibly clicks.



6. Allow the Helmet motor speed to stabilize (up to a minute). Notice that the Yellow LED stays off.



7. Close the tape end across the open Air Inlet Channel to close off all air flow. Allow the Helmet to stabilize. Notice the Yellow LED turns on in about 5-20 seconds. Open the tape as soon as the Yellow LED turns on (as in the previous step 6.)

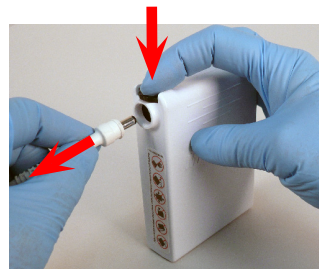

8. Disconnect the Helmet Power Cord from the Battery - push the Secure Connection Button down, pull Cord Connector out, release the Button.



9. Remove the tape covering the air inlet channel of the Filter Cover Cap.



CAUTION

Ensure the Tape is opened and the Yellow LED goes out immediately after demonstrating that the Yellow LED comes on with it closed.



CAUTION

Ensure the Power Cord is disconnected from the Battery before performing step 9.

6. Standard System Donning and Doffing



CAUTION

If there is any question about the disinfection status of the eCAPR System due to a previous use, it is recommended to disinfect it before using.

This section describes Donning and Doffing the Standard System with the most common face cover, the DLC. The majority of all the procedures in this section are applicable to other face and head cover donning and doffing, particularly with regards to battery, charger, helmet adjustments, and facial fit. Differences for other configurations are covered in the respective sections for those other face and head covers.

Don the System



1. Obtain a fully charged battery. (Charger LED should be green after battery is connected to charger for more than 10 seconds.)

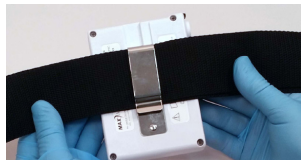

2. Assemble the battery onto the belt. Place the top edge of the Belt under the Battery Clip. Move the Belt fully under and up to the top of the Clip.

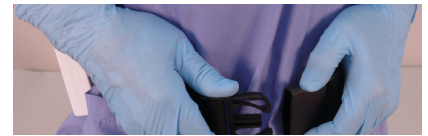

3. Place the belt comfortably around the waist with the battery near the side-back of the right hip.



4. Remove a DLC from the DLC dispensing box and attach the DLC Lens, with the DLC cuff facing the inside to the helmet. Remove the DLC Protective film.

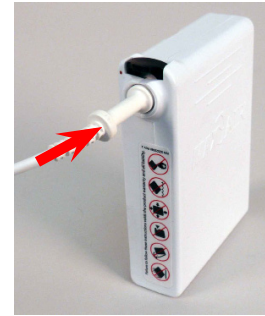

5. Connect the Helmet Power Cord to the Battery. Push the Power Cord Connector into the Battery Receptacle until the Secure Connection audibly clicks.



6. Loosen the ratchet adjustment knob counter-clockwise to ensure the Helmet will easily fit over the head.



7. Hold the Helmet by the rear headband in one hand, pull the front top edge of the DLC Cuff down, and place your chin into the DLC Cuff. Then, pull the Helmet over and down on to your head.



WARNING

After donning, if conditions 1 and 2 both are not achieved, switch to the other size DLC and repeat steps 1 through 6 above.



8. Slide your fingers between the Cuff and face from each temple down and under your chin to pull the DLC Flappers away from the lens, and to properly position the cuff.



FCC Side Tabs
DLC Flappers

Condition 1: Ensure the DLC Flappers are away from the Lens, positioned perpendicular to your temples, and in front of the FCC Side Tabs.

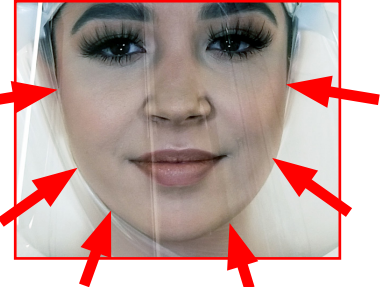

Condition 2: Ensure slight tension on the cuff is felt continuously while sliding the index or first finger between the cuff and the face all along the chin and up to the temples, from the right side of the face to the left.



CAUTION

If the Helmet is not secure and comfortable on the head, it may be necessary to change the Height Adjustment. The Height Adjustment raises and lowers the rear headband and the angle of the helmet with respect to the head, and properly positions the DLC Lens from the chin. This optimizes a secure and comfortable fit in conjunction with the Adjustment Knob for optimizing the circumference of the Headband. It also aids in proper positioning for easy visualization of the LED Safety Status Indicators. If necessary, unsnap the Height Adjustment tabs on each side of the Helmet Liner and reposition upward or downward, until the optimum fit for comfort and security is determined.

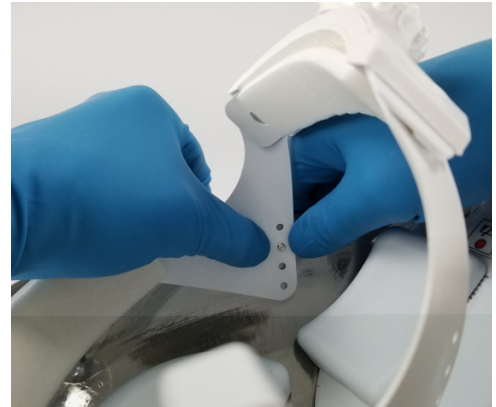

CAUTION

Optimum setting is achieved when the helmet is secure on the head for all movements required and the front headband is within 1/2 inch of the eyebrows to allow good visualization of the LED Safety Status Indicators in the upper peripheral vision. Be sure to have both Height Adjustment tabs in the same position.

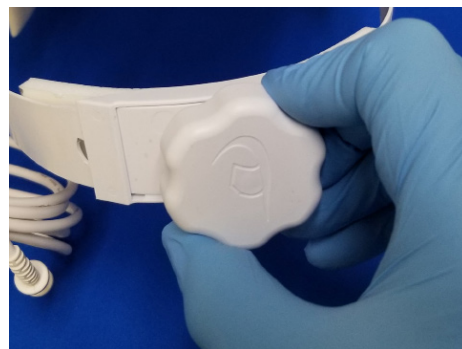
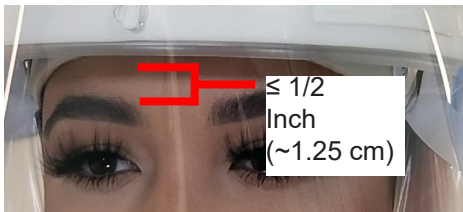

9. Position the Helmet so that the front headband is within 1/2 inch of the eyebrows and the rear headband is resting under the occipital bone above the vertebrae on the neck, and then tighten the Adjustment Knob clockwise to ensure the most secure fit of the helmet on the head for all activities. Do not over tighten to cause discomfort.

There are two alternative protocols for doffing the eCAPR Helmet:

- Alternative A is doffing the Helmet leaving the DLC attached for the next use.
- Alternative B is for removing the DLC for disposal and then doffing the Helmet.

Doffing the System: Alternative A



1. Loosen the rear Headband Adjustment Knob (turn counterclockwise).



2. Hold the front top of the Helmet in one hand and with the other hand on the Adjustment Knob; lift the Helmet up and off the head.

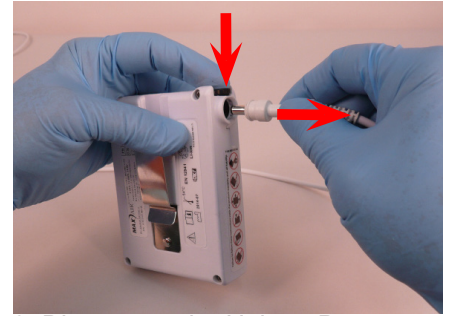

3. Disconnect the Helmet Power Cord from the Battery - push the Secure Connection Button down, pull Cord Connector out, release the Button.



4. Disconnect the Battery Belt from around the waist by un-snapping the buckle.



5. With the Charger connected to the mains wall power, connect the Charger Cord to the Battery. Push the Charger Cord Connector into the Battery Receptacle until it is fully seated.



6. The entire eCAPR System may be decontaminated, cleaned and/or stored at this time.

7. If desired, all components of the eCAPR System may be disassembled and each component decontaminated, cleaned and/or stored at this time.

Doffing the System: Alternative B

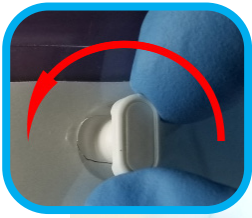

1. Turn the FCC front TurnClip horizontally, grasp each DLC side Flapper and pull the DLC off the FCC side Attachment Adapters and away from the Helmet sides.



2. Continue pulling the DLC forward off the front TurnClip and away from the Helmet. Dispose of the DLC according to your institution's protocol for contaminated waste.



3. Loosen the rear Headband Adjustment Knob (turn counterclockwise). Lift the Helmet up and off the head.

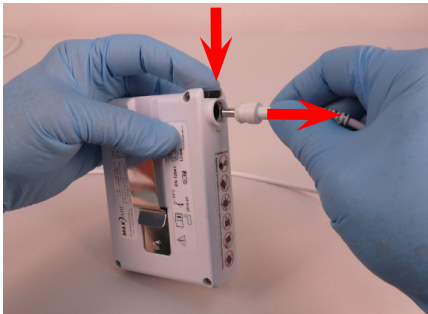

4. Disconnect the Helmet Power Cord from the Battery - push the Secure Connection Button down, pull Cord Connector out, release the Button.



5. Disconnect the Battery Belt from around the waist by un-snapping the buckle.



6. With the Charger connected to the mains wall power, connect the Charger Cord to the Battery. Push the Charger Cord Connector into the Battery Receptacle until it is fully seated.



WARNING

Refer to Section 9, Instructions For Use: Charger, for details on proper use of chargers and for charging batteries.

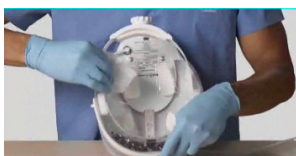

7. The entire eCAPR System may be decontaminated, cleaned and/or stored at this time.

8. If desired, all components of the eCAPR System may be disassembled and each component decontaminated, cleaned and/or stored at this time.

7. Comfort Strips, P/N 2000-201

Assembling and Disassembling the Comfort Strips

**NOTE**

Only one side of the comfort strip will attach to the hook tape on the Headband.

1. To remove a damaged or soiled Front Comfort Strip, pull it away and off of the Headband.
2. To attach a new Front Comfort Strip, align it parallel to the Headband with the loop side facing the Headband and press it on.

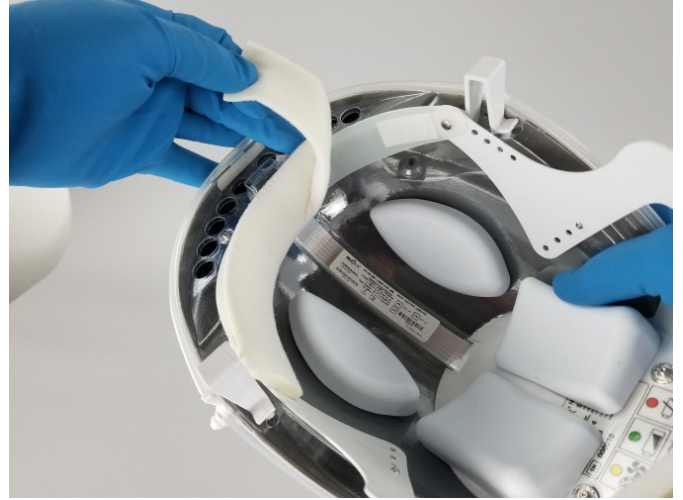

The Rear Comfort Strip is closed cell foam and may easily be cleaned with a decon wipe and reused until worn or otherwise unsuitable for use.

1. To remove a damaged or soiled Rear Comfort Strip, pull it away and off of the Headband.
2. To attach a new Rear Comfort Strip, align it parallel to the Headband with the loop side facing the Headband and press it on.

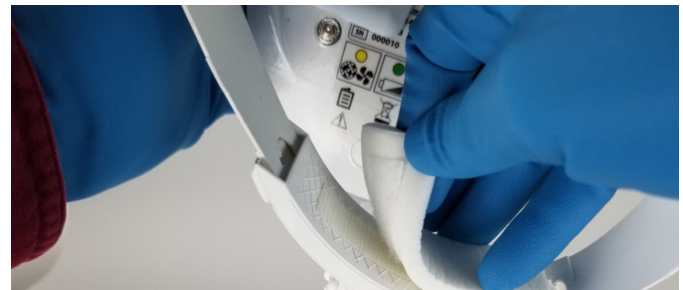

8. Li-Ion Battery

Three Secure Lock Battery choices are available, including -

- 2500-36TSC (01532104) - typically 4-10 hours/charge
- 2500-37TSC (01532161) - typically 12-15 hours/charge

All batteries are handled similar to the 2500-36TSC as indicated in these section.



CAUTION

Inspect the Battery for damage before every use. Do not use if damaged.
Always start with a fully charged Battery and use with the MAXAIR System only.
Fully recharge Batteries immediately after every use.
Charge the Battery only with a MAXAIR Lithium Ion Charger. See the Charger's Instructions for use.
If the Charger LED is red when the Battery is connected, the Battery is not fully charged.
If it is necessary to use a non-fully charged Battery, precede using extreme CAUTION. Take very careful note of the Helmet LED Safety Status Indicators when the Battery is connected to the Helmet Power Cord. Refer to the Helmet LED Safety Status Indicator LED Matrix table in Section 3.7.5 to estimate the amount of useful time remaining on the Battery if it is not in a fully charged condition. Proceed once it is determined that there is sufficient charge in the Battery for the next activity.

Securing the Battery



1. Obtain a fully charged battery. (Charger LED should be green after battery is connected to charger for more than 10 seconds.)

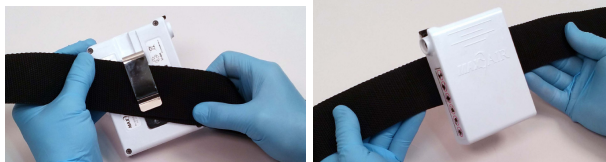

2. Assemble the battery onto the belt. Place the top edge of the Belt under the Battery Clip. Move the Belt fully under and up to the top of the Clip.



3. Place the belt comfortably around the waist with the battery near the side-back of the right hip.



CAUTION

Ensure the power cord connector is fully secured into the battery connector socket. Push the cord connector all the way in until the battery connector socket stops further inward movement of the power cord connector. Handle the power cord by the connector, not the cord.

Connecting the Battery to the Helmet

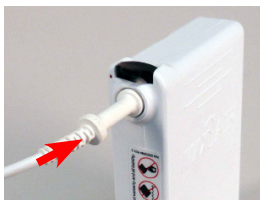

To initiate air-flow, connect the Helmet Power Cord to the Battery. Push the Power Cord Connector into the Battery Receptacle until the Secure Connection audibly clicks.

Disconnecting the Battery from the Helmet

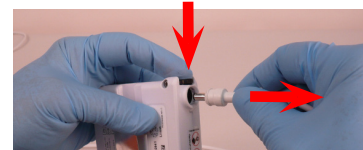

Disconnect the Helmet Power Cord from the Battery - push the Secure Connection Button down, pull Cord Connector out, release the Button.

Material safety data sheet (MSDS) available upon request.

9. Charger, P/N 2600-02 (01432202)



WARNING

The Charger should only be used in an isolated area away from patients and other activities, and away from flammable materials. Inspect the charger for damage before every use. Do not use if damage is apparent or suspect.

A battery should be connected to a charger only until the Charger LED turns Green indicating a fully charged Battery.

When the Charger LED turns Green, the Battery should be disconnected from the Charger.

Refer to Section 19 for details regarding intermittent use and storage of batteries.

Intended Use

1. This Charger is designed for indoor use only and should not come into contact with water or excessive dust. To prevent overheating the product should not be covered during use.
2. The mains socket should be easily accessible. In the event of operational error, the plug should be immediately removed from the socket.
3. This Charger is designed for use with MAXAIR Lithium-Ion Batteries. For safety reasons, this Charger must be used only for MAXAIR Batteries which have the right number of cells in series: Output voltage divided by 4.1V or 4.2V.
4. The Charger contains dangerous voltages and the cover should not be removed.
5. All recommended maintenance work should be carried out by qualified personnel who can get assistance by contacting the manufacturer's agent.
6. A fuse protects the Charger against short circuiting and overloading.
7. This symbol  means that the charger is double insulated (Insulation Class II)
8. If the Charger is mounted in a vehicle it can only be used when the vehicle is not in use.
9. If the Charger is labeled "EN60601-1" and therefore it complies with the requirements of electro-medical equipment, it can be used in hospital environments, etc.
10. The Charger has a plastic casing; avoid its coming into contact with oils, grease etc., as most types of plastic can be broken down by chemicals and solvents.

Charging Instructions



1. Connect the Charger (single and/or 6-Gang) to an appropriate grounded wall mains power source (120-240 VAC, 50-60 Hz) before connecting to the Battery(ies). The Charger green status LED should blink on (before connecting battery).



2. Connect the Battery(ies) to the Charger(s) by pushing the Charger Cord Connector into the Battery Connector Receptacle until fully seated. The Charger LED should change from blinking green to orange and then to blinking orange as the charging cycle continues. If the LED is Orange after being connected to the Battery for 10 seconds, the Battery is ready for use.



3. When charging is complete, the Charger LED should change to orange. Disconnect Battery(ies) from Charger(s) by pulling the Charger Cord Connector from the Battery Connector receptacle. The Battery(ies) is(are) ready for use.



WARNING

The Charger has internal fuses which blow if a fault occurs in the charger. Additionally, the Charger is equipped with a fuse switch which cuts off the unit in the case of a reverse polarity connection to the Battery. If a Charger fails, contact Customer Service at 1-800-443-3842 for a Return Material Authorization (RMA).

2600-01 LED Indicator and Charge Status

Fast charge (Red LED)

- The charger is in constant current mode.
- Charge current is at the maximum.

Final charge (Red LED)

- The charger is in constant voltage mode.
- Charge current is less than the maximum.
- The battery is normally 80-95% charged.
- The charger stays in this mode until the charge current decreases to charge termination level.

Charge completed (Green)

- The charge is stopped.
- Charge current is zero.

2600-01 Charging Diagram

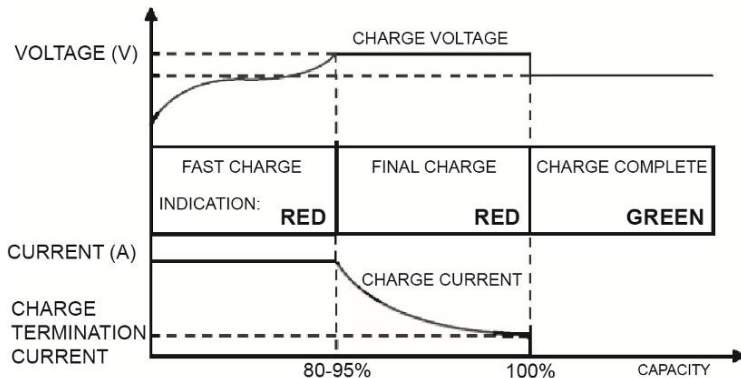

2600-02 LED Indicator and Charge Status

Step 1 - Constant Current Charge cycle starts automatically when connected to mains and battery is connected to charger. Charging is with maximum charger current. The LED is YELLOW. This allows rapid charging to 80-95% capacity.

Step 2 - Constant Voltage (Timer) Charge. Charge voltage is constant and charge current is decreasing. The LED is FLASHING YELLOW. This continues until current has decreased to end of charge detection level or until Timer runs out (8 hours). The battery is charged to full capacity.

Step 3 - Charge Complete. The LED turns GREEN, the battery is fully charged, the charge current is zero, and the battery has been charged to its full capacity. A new charge cycle will be initiated if battery voltage decreases with 0.1 V/cell.

2600-02 Charging Diagram

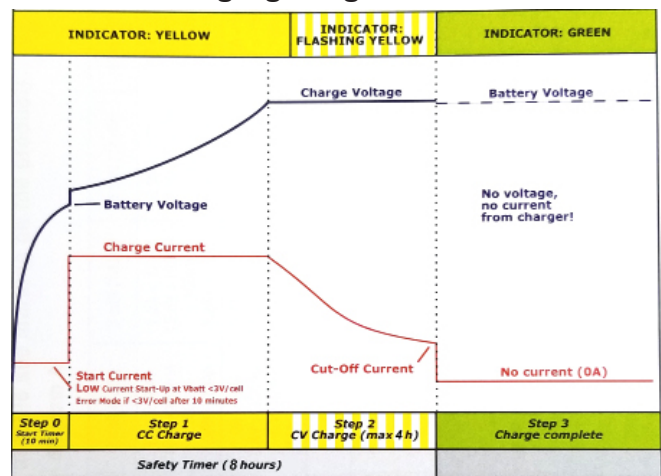

- FLASHING GREEN - Battery not connected.
- 2 Red Blinks - Battery is connected with wrong polarity.
- 3 Red Blinks - Charger output is shorted.
- 4 Red Blinks - Battery voltage low and may need replacing.
- 5 Red Blinks - Safety timer has run out - replace battery.
- LED Off - Battery voltage is too high - replace battery.

Charging Protection from Electrical Surges

Always connect the MAXAIR Charger directly to a Surge Protection Device, adequate for all anticipatable occurrences, during all charging activities of MAXAIR LIBs, and whenever the Charger is connected to a mains power source.

To choose an appropriate surge protector you should consult with your Engineering department regarding specifics to your physical plant and geographical environment. You may want to consider the following common fundamentals -

- ▲ Indicator light – surge protectors will not last forever – when a surge protector properly diverts a surge, the protector itself can be damaged in the process. An indicator light will indicate that the surge protector is working fine.
- ▲ UL Rating - good surge protectors come with a UL rating (or equivalent regulatory mark for non U.S. countries, e.g. CE Mark, etc.), a rating put out by the independent Underwriters Laboratories that tests the safety of electronic devices.
- ▲ Clamping voltage - the voltage measurement that prompts the surge protector to start redirecting the excess electricity away from the plugged-in devices.
- ▲ A surge protector with a lower clamping voltage will trigger earlier, thus better protecting electrical devices.
- ▲ Joule rating - the maximum amount of energy the surge protector can absorb. If the surge exceeds this maximum, the surge protector will be rendered useless. The higher the joule rating, the more energy can be absorbed by the surge protector, therefore, a higher joule rating will often indicate a longer lifespan for the product.



Gang Battery Chargers

2602-06 6-Gang Battery Charger

Includes six 2600-02 Chargers that can be charged simultaneously from one wall power outlet.

2602-06B 6-Gang Charger Bracket

The 6-Gang Charger Bracket is for use with from one to six already purchased 2600-02 Chargers.

Installing the 6-Gang Battery Charger and Bracket

The 6-Gang Charger and 6-Gang Charger Bracket ship with basic mounting hardware for mounting into solid wood and plasterboard.

Locate a suitable location for placing them on a surface. If it is desirable to mount them to a wall, cabinet, etc., use the mounting hardware supplied.

Charging Batteries with the 6-Gang Battery Charger

Plug the power cord into a standard 110v outlet.

If necessary, connect from one to six 2600-02 Chargers into the clips, at any given time, and connect the chargers to the six-connector cable using the 1-6 charger connectors on the power cable.



NOTE

Each connected Charger's LED should be green before a Battery is connected for charging.
Connect batteries to appropriate Chargers and the Charger's green LED should turn red.



NOTE

If a charger LED remains red when a Battery is connected, the Battery is charged sufficiently and is ready for use.
The Charger LED should change back to green when the Battery is charged, typically in 4-6 hours for a fully drained Battery.

2600-01 (01432089)



2602-06

2600-02 (01432202)



Label View



Indicator View

2602-06B

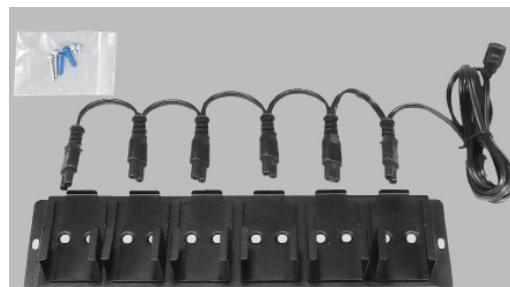

10. Helmet, P/N 2079-03 (03531214, 03531021, 01031269, 2590-05)

The 2079-03 Helmet Assembly is a component of the MAXAIR eCAPR Line of Powered Air Purifying Respirators; as shipped it consists of the 03531214 Helmet, 03531021 Liner, 01031269 SnapOn Cage, and 2590-05 Power Cord.



CAUTION

Always place a Filter Cartridge and Filter Cover Cap, or a SnapOn Cage on the Helmet when it is not in use.

Prepping the Helmet for use



1. Unsnap the left and right side Snap Tabs of the SnapOn Cage.



2. Unsnap the rear Snap Tab and remove the SnapOn Cage lifting upward and off the Helmet.



3. The helmet is ready to assemble the appropriate Filter Cartridge.

Prepping the Helmet for Storage

1. Clean all dirty surfaces per Section 17.
2. Assemble a Filter Cartridge, Section 12, or the SnapOn Cage, reverse of steps 1-3 directly above, Prepping the Helmet for use.
3. Follow storage instructions per Section 18.

11. Helmet Liner, P/N 2071-07 (03531148)

CAUTION
 Prior to assembly, inspect and verify the Liner mounting holes (4) are in good condition. If the mounting holes are worn and connections to the helmet are weak or loose, replace the Liner.
 Always assemble the Helmet Liner to a Helmet that already has a Helmet Protector/Cage or Filter Cartridge attached.

Assembly

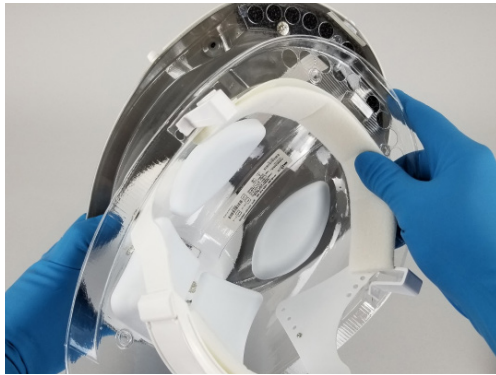

NOTE
 The Helmet Liner outer "cupped edge" fits up against and over the bottom edge of the Helmet.



1. Support the Helmet with one hand and position the Liner inside the Helmet. Adjust the power cord over the power cord slot.

2. Align and place the Liner outer "cupped edge" under, up against, and over the bottom edge of the Helmet, all around the Helmet.

3. Front Left and Right: Align and snap down the Liner front holes to the Helmet front Snaps with your thumbs.

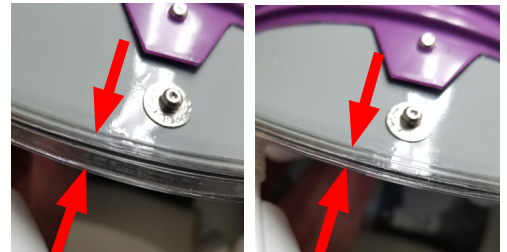
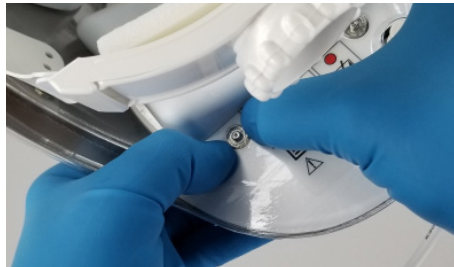

4. Align the Power Cord with the Liner Cord Slot and press the bottom of the Liner against the Helmet so the Liner Snap Holes are against the Helmet bottom snaps.

5. Rear Left and Right: Snap the Liner rear holes on to the Helmet rear snaps.

6. Snap the Liner rear lip against the Helmet rear by pressing/squeezing them together.

Disassembly



1. Align the Helmet Power Cord to the Liner cord slot.



2. Grasp the Liner by cupping the fingers up under the front Headband, with the thumb against the Helmet front edge.



3. Apply force with thumbs and fingers in opposite directions to disengage the front mounting snaps.



4. Disengage rear mounting snaps by lifting the Liner up and away from the Helmet.

During Use

If the Helmet is not secure and comfortable on the head, it may be necessary to change the Height Adjustment. The Height Adjustment raises and lowers the rear headband and the angle of the helmet with respect to the head, and properly positions the DLC Lens from the chin. This optimizes a secure and comfortable fit in conjunction with the Adjustment Knob for optimizing the circumference of the Headband. It also aids in proper positioning for easy visualization of the LED Safety Status Indicators. If necessary, unsnap the Height Adjustment tabs on each side of the Helmet Liner and reposition upward or downward, until the optimum fit for comfort and security is determined.



CAUTION

Optimum setting is achieved when the helmet is secure on the head for all movements required and the front headband is within 1/2 inch of the eyebrows to allow good visualization of the LED Safety Status Indicators in the upper peripheral vision. Be sure to have both Height Adjustment tabs in the same position.

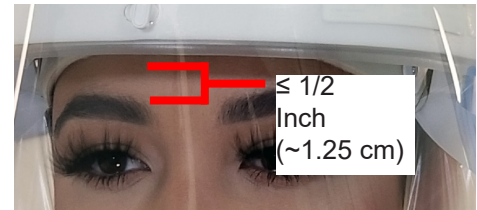

Position front headband within 1/2 inch of eyebrows for visualization of the Safety LEDs.

12. Filter Cartridge P/N 2167-10 (07831175)

The Filter Cartridge is a component of the MAXAIR eCAPR Line of Powered Air Purifying Respirators.



CAUTION

Ensure that the black Filter Cartridge-to-Helmet Gasket Seal is uniform and flat continuously around the Filter Cartridge.

Helmet and Filter Media are exposed. Handle with care. Avoid rough contact with filter media.

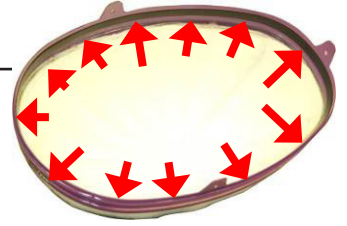

Assembly



1. Hold the Helmet upright with one hand; with the other hand align the Filter Cartridge with the Helmet rear upper snap.

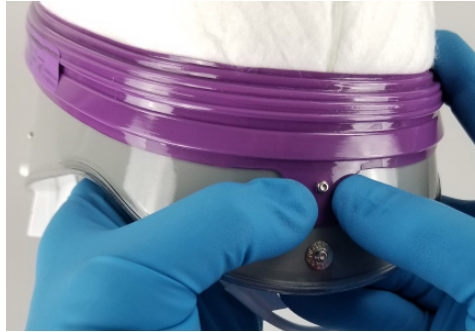

2. Rear Snap: Snap and secure the Filter Cartridge rear tab in place onto the Helmet rear upper snap.



3. Center and lift the left and right side Filter Cartridge snap tabs such that they sit on top of the Helmet side upper snaps.

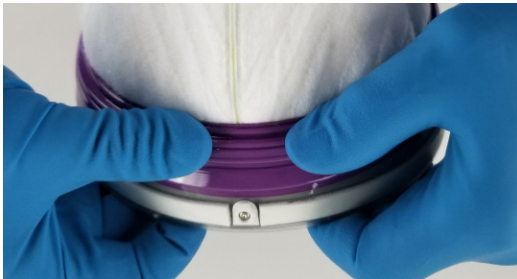

4. Using the front top step of the Filter Cartridge retainer ring, firmly push the Filter Cartridge down towards the Helmet front alignment post.



5. Similarly press the Filter Cartridge ring down on each side so the side tabs are in line with the Helmet side upper snaps.



6. Snap and secure each Filter Cartridge side snap tab on to each respective Helmet side upper snap.

Disassembly



1. Lift and unsnap the Filter Cartridge Left, Right, and rear snap tabs.



2. Grasp the Filter Cartridge at the rear Snap Tab and with an up and forward motion lift the Filter Cartridge up and off the Helmet.

13. Filter Cover Cap (FCC), 2061-08 (01031284)

The 2061-08 Filter Cover Cap is a component of the MAXAIR eCAPR Line of Powered Air Purifying Respirators and provides protection for MAXAIR Filter Cartridges in various Cuff and Shroud configurations.



WARNING

Never mount a FCC on a Helmet until a fully functional Filter Cartridge is securely in place on the Helmet.



CAUTION

Prior to assembly, visually inspect the perimeter of the Helmet and verify the Helmet edges are tucked inside the Liner edges. If not, manually tuck the Helmet outer shell gray edges under and inside of the Helmet inner shell clear lip - all around the Helmet.



Assembly

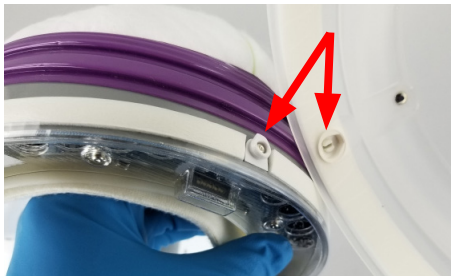

1. Align the Helmet Front Adapter to the indentation on the inside of the FCC Front Adapter.



2. Hold the Helmet/Liner/ Filter Cartridge upright by its rear underside with one hand, insert the Helmet Front Adapter into the inside of the FCC Front Adapter, and pull the FCC back, over and down onto the Helmet.

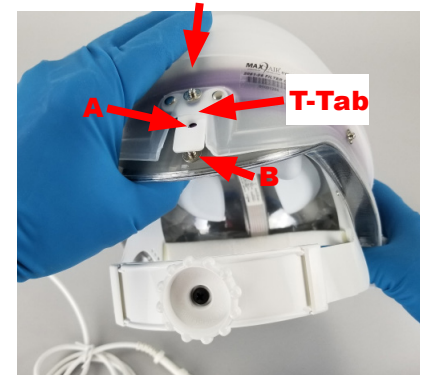

3. Pull the FCC fully down on the Helmet (Squeeze together) to align the FCC T-Tab hole (A) over the Helmet rear Bottom Snap (B).

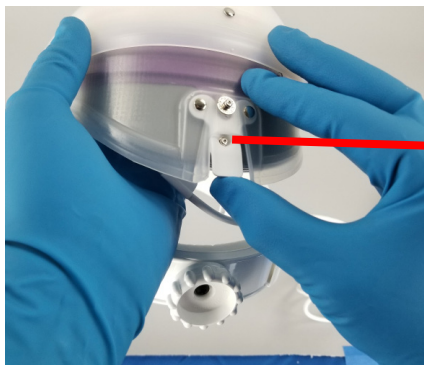

4. Ensure that the T-Tab is fully snapped down on the Helmet rear Bottom Snap (use thumb if necessary to press in place).

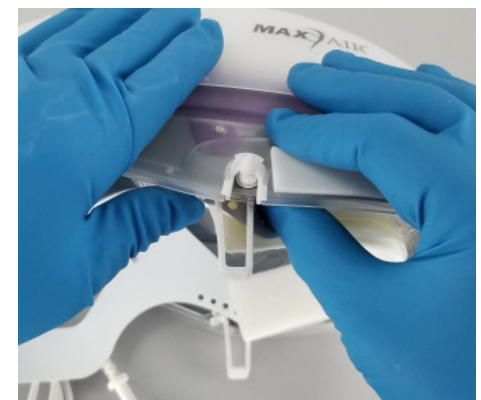

5. Ensure that each FCC Side Adapter is positioned fully down over each Helmet Side Adapter.



1. With one hand, hold the Helmet and FCC with the thumb against the FCC and the fingers on the inside of the Helmet. With the other hand, pull up and out on the FCC T-Tab and unlatch it from the Helmet FCC Rear Bottom Snap.



2. Continue pulling up on the T-Tab with one hand. Using a sliding motion with the thumb moving up and pushing the FCC up, pull the Helmet down with the fingers (opposite the thumb and FCC).



3. Lift the FCC up and off the helmet.

14. Disposable Lens Cuff (DLC)



P/N 2366-02SM
Small-Medium
REF 01031556

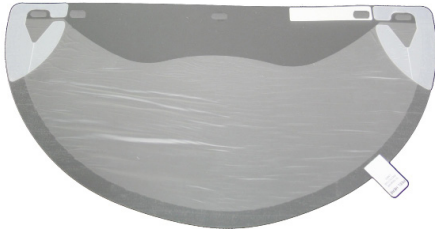

P/N 2366-02ML
Medium-Large
REF 01031555



WARNING

Use only if package is received unopened and contents are undamaged. If damage is noted, contact the shipper for replacement or repair.

Prior to using any MAXAIR® System or component, be sure to be familiar with the system's NIOSH approved configuration.

Read and understand the User's Instructions Manual.

Failure to follow the User's Instructions Manual may be hazardous to the user's health.

The institution using this product in any application is responsible for determining the appropriateness of this equipment relative to regulatory requirements. Bio-Medical Devices Intl, Inc. does not recommend the appropriate systems for a particular institution or facility.

DO NOT use if any component is damaged. If any components are damaged or contaminated and therefore unfit for safe and effective use, they should be replaced immediately.

Use only MAXAIR Systems/ NIOSH approved compatible components.

The DLCs are not intended for use against oily particulates such as paint mist, oil mist or detergents.

NOT for use in atmospheres immediately dangerous to life or health (IDLH), and atmospheres containing less than 19.5% oxygen.

Follow current local regulations governing biohazard waste to safely dispose of used shrouds.

If you need more information, contact your BMDI Sales Representative, or call BMDI customer service at 1-800-443-3842.

Intended Use

The MAXAIR® eCAPR® DLC (Disposable Lens Cuff) Systems are intended to filter aerosolized and droplet particulates.

DLCs are designed for single use applications.

For Use With

The MAXAIR 2366-02 DLC is a component of the MAXAIR eCAPR Systems and is intended to be donned with a MAXAIR eCAPR Powered Air Purifying Respirator (PAPR) 2079-03 Helmet and a 2167-10 Filter Cartridge or alternate.

Standard eCAPR-36 System for 2366-02 DLC



1. 2079-03 Helmet with 2071-05 Liner, 2590-05 Power Cord, and 2051-07 Cage (removed)	2. 2500-37TSC Battery*
4. 2600-01 Battery Charger**	3. 2000-76 Battery Belt
6. 2061-08 Filter Cover Cap	5. 2167-10 Filter Cartridge
	7. 2366-02 ML or SM DLC Cuff ***

* Alternate Batteries include the 2500-36TSC and 2500-30TSC.

**Alternate Charger includes the 2600-01.

***Alternate Cuffs include the 2365-02 ML and SM.

Materials

DLC Lens is PETG
 DLC Cuff is Polyurethane

Specifications

Temperature Limits: 490C
 Efficiency Rating: HE

Regulatory

NIOSH



NOTE

Instructions are the same if using the 2365-02ML and 2365-02SM.



WARNING

For persons with medium to large faces, start with the 2366-02ML DLC. For persons with a very small face, start with the 2366-02SM DLC.

The DLC Cuff side must face to the inside of the Helmet; the Lens side must face to the outside of the Helmet.

Assembly - before donning the Helmet



1. Obtain the appropriate DLC from the DLC dispensing box.

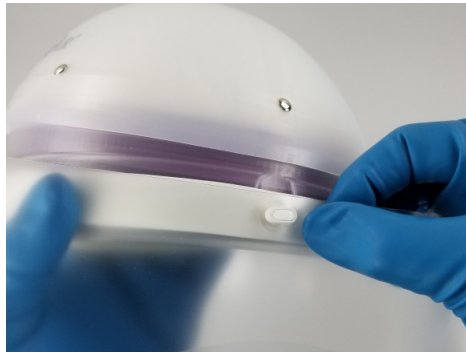

2. Place the FCC front TurnClip in the horizontal position, then align and snap the DLC Front Alignment Hole over the FCC front TurnClip.



3. Reposition the FCC front TurnClip in the vertical position; this will secure the front of the DLC to the FCC.



4. Align and snap one DLC Side Attachment Hole over the respective FCC Side Attachment Post.



5. Align and Snap the other DLC Side Attachment Hole over the FCC Side Attachment Post.



6. Pull the DLC Peel Tab up, over and to the left to remove the Lens Protective Cover off the Lens.

Disassembly - after doffing the Helmet

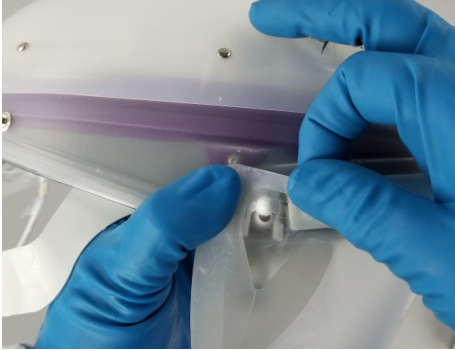

1. Grasp one side DLC flapper and lift away from the Side Attachment Post.

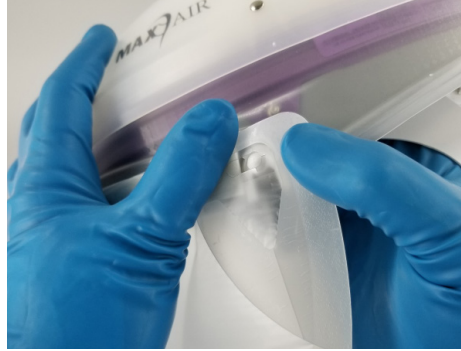

2. Grasp the other side DLC flapper and lift away from the Side Attachment Post

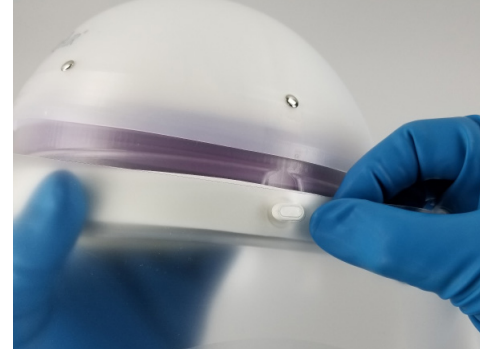

3. Turn the FCC front TurnClip to the horizontal position, then grasp the center of the DLC and lift away and off the TurnClip and the Helmet. Dispose of the DLC according to your institution's protocol for contaminated waste.

Disassembly - prior to doffing the Helmet

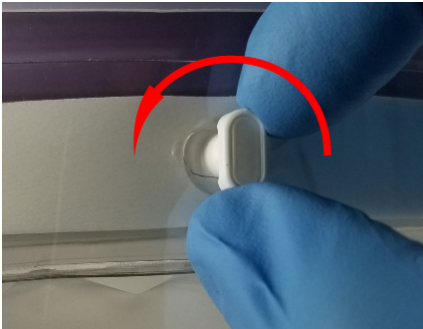

1. Turn the FCC front TurnClip to the horizontal position



1. Grasp both side DLC flappers and lift out and away from the FCC Side Attachment Posts.



2. Continue to pull the DLC forward and away from the Helmet. Dispose of the DLC according to your institution's protocol for contaminated waste.

Replacing a DLC for continued use with the Helmet donned



1. Obtain the correct replacement DLC from the corresponding DLC dispensing Box.

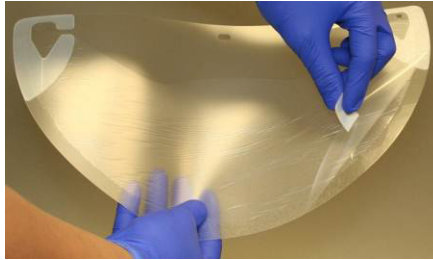

2. Pull the DLC Peel Tab up, over and to the left to remove the Lens Protective Cover off the Lens.

3. Disassemble the DLC from the Helmet per the instructions on the previous page "Disassembly - prior to doffing the Helmet".



3. Align FCC front TurnClip horizontally, snap the DLC Front Alignment Hole over the TurnClip. Position the TurnClip vertically to lock DLC in place.

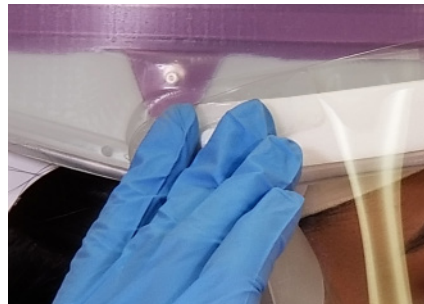

4. Align and snap one DLC Side Attachment Hole over the respective FCC Side Attachment Post. Repeat for the other side.



5. Slide your fingers between the Cuff and face from each temple down and under your chin to pull the DLC Flappers away from the lens, and to properly position the cuff.



WARNING

After donning, if conditions 1 and 2 both are not achieved, switch to the other size DLC and repeat steps 1 through 6 above.



FCC Side Tabs
DLC Flappers

Condition 1: Ensure the DLC Flappers are away from the Lens, positioned perpendicular to your temples, and in front of the FCC Side Tabs.

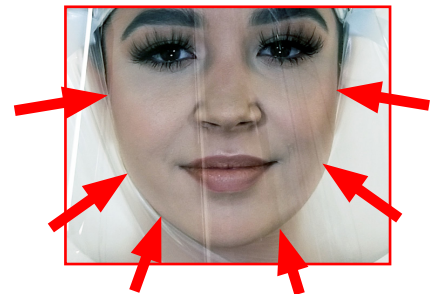

Condition 2: Ensure slight tension on the cuff is felt continuously while sliding the index or first finger between the cuff and the face all along the chin and up to the temples, from the right side of the face to the left.



WARNING

If there is any question about the disinfection status of the eCAPR System due to a previous use, it is recommended to disinfect it before using.



1. Obtain a fully charged battery. (Charger LED should be green after battery is connected to charger for more than 10 seconds.)

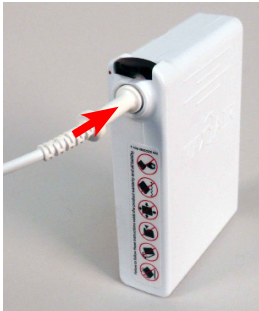

4. Connect the Helmet Power Cord to the Battery. Push the Power Cord Connector into the Battery Receptacle until the Secure Connection audibly clicks.

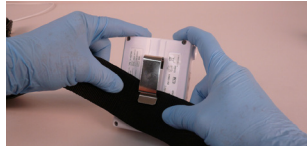

2. Assemble the Battery onto the Belt. Place the top edge of the Belt under the Battery Clip. Move the Belt fully under and up to the top of the Clip. Place the belt comfortably around the waist with the battery near the side-back of the right hip.

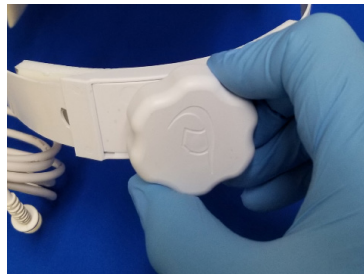

5. Loosen the ratchet adjustment knob counter-clockwise to ensure the Helmet will easily fit over the head.



3. Remove a DLC from the DLC dispensing box and attach the DLC Lens, with the DLC cuff facing the inside to the helmet. Remove the DLC Protective film.

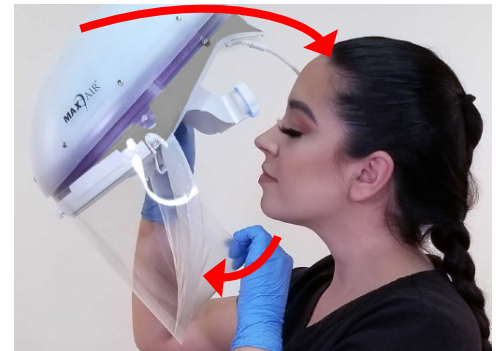

6. Hold the Helmet by the rear headband in one hand, pull the front top edge of the DLC Cuff down, and place your chin into the DLC Cuff. Then, pull the Helmet over and down on to your head.



WARNING

After donning, if conditions 1 and 2 both are not achieved, switch to the other size DLC and repeat steps 1 through 6 above.



7. Slide your fingers between the Cuff and face from each temple down and under your chin to pull the DLC Flappers away from the lens, and to properly position the cuff.



FCC Side Tabs
DLC Flappers

Condition 1: Ensure the DLC Flappers are away from the Lens, positioned perpendicular to your temples, and in front of the FCC Side Tabs.

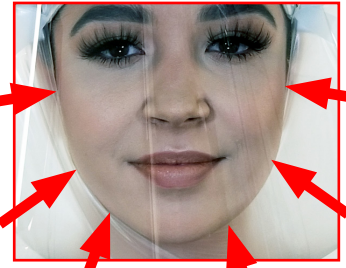

Condition 2: Ensure slight tension on the cuff is felt continuously while sliding the index or first finger between the cuff and the face all along the chin and up to the temples, from the right side of the face to the left.



CAUTION

If the Helmet is not secure and comfortable on the head, it may be necessary to change the Height Adjustment. The Height Adjustment raises and lowers the rear headband and the angle of the helmet with respect to the head, and properly positions the DLC Lens from the chin. This optimizes a secure and comfortable fit in conjunction with the Adjustment Knob for optimizing the circumference of the Headband. It also aids in proper positioning for easy visualization of the LED Safety Status Indicators. If necessary, unsnap the Height Adjustment tabs on each side of the Helmet Liner and reposition upward or downward, until the optimum fit for comfort and security is determined.

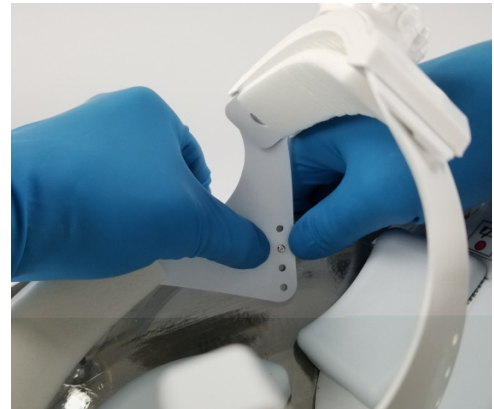

CAUTION

Optimum setting is achieved when the helmet is secure on the head for all movements required and the front headband is within 1/2 inch of the eyebrows to allow good visualization of the LED Safety Status Indicators in the upper peripheral vision. Be sure to have both Height Adjustment tabs in the same position.

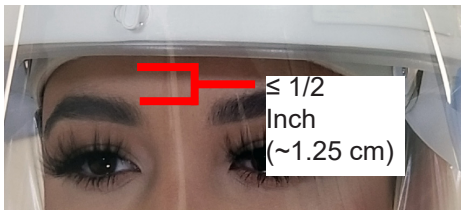

8. Position the Helmet so that the front headband is within 1/2 inch of the eyebrows and the rear headband is resting under the occipital bone above the vertebrae on the neck, and then tighten the Adjustment Knob clockwise to ensure the most secure fit of the helmet on the head for all activities. Do not over tighten to cause discomfort.

There are two alternative protocols for doffing the eCAPR Helmet:

- Alternative A is doffing the Helmet leaving the DLC attached for the next use.
- Alternative B is for removing the DLC for disposal and then doffing the Helmet.

Doffing the System: Alternative A



1. Loosen the rear Headband Adjustment Knob (turn counterclockwise).



2. Hold the front top of the Helmet in one hand and with the other hand on the Adjustment Knob; lift the Helmet up and off the head.

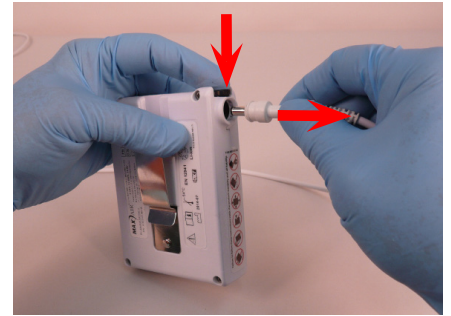

3. Disconnect the Helmet Power Cord from the Battery - push the Secure Connection Button down, pull Cord Connector out, release the Button.



4. Disconnect the Battery Belt from around the waist by un-snapping the buckle.



5. With the Charger connected to the mains wall power, connect the Charger Cord to the Battery. Push the Charger Cord Connector into the Battery Receptacle until it is fully seated.

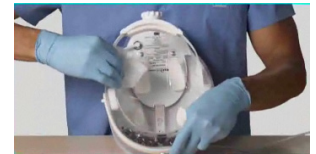

6. The entire eCAPR System may be decontaminated, cleaned and/or stored at this time.

7. If desired, all components of the eCAPR System may be disassembled and each component decontaminated, cleaned and/or stored at this time.

DoFFing the System: Alternative B

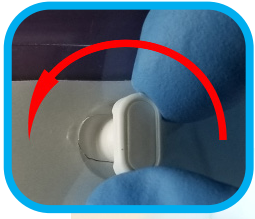

1. Turn the FCC front TurnClip horizontally, grasp each DLC side Flapper and pull the DLC off the FCC side Attachment Adapters and away from the Helmet sides.



2. Continue pulling the DLC forward off the front TurnClip and away from the Helmet. Dispose of the DLC according to your institution's protocol for contaminated waste.



3. Loosen the rear Headband Adjustment Knob (turn counterclockwise). Lift the Helmet up and off the head.

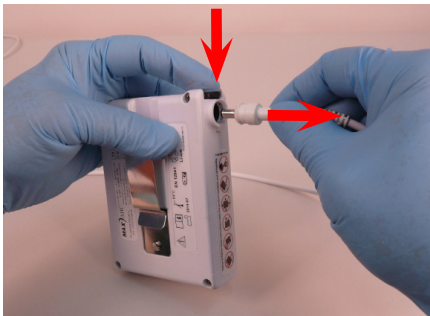

4. Disconnect the Helmet Power Cord from the Battery - push the Secure Connection Button down, pull Cord Connector out, release the Button.



5. Disconnect the Battery Belt from around the waist by un-snapping the buckle.



6. With the Charger connected to the mains wall power, connect the Charger Cord to the Battery. Push the Charger Cord Connector into the Battery Receptacle until it is fully seated.



WARNING

Refer to Section 9, Instructions For Use: Charger, for details on proper use of chargers and for charging batteries.



7. The entire eCAPR System may be decontaminated, cleaned and/or stored at this time.

8. If desired, all components of the eCAPR System may be disassembled and each component decontaminated, cleaned and/or stored at this time.

15. DLC Shroud, P/N 2264-01



P/N 2264-01SM
Small-Medium
REF 01031562

P/N 2264-01ML
Medium-Large
REF 01031565



WARNING

Use only if package is received unopened and contents are undamaged. If damage is noted, contact the shipper for replacement or repair.

Prior to using any MAXAIR® System or component, be sure to be familiar with the system's NIOSH approved configuration.

Read and understand the User's Instructions Manual.

Failure to follow the User's Instructions Manual may be hazardous to the user's health.

The institution using this product in any application is responsible for determining the appropriateness of this equipment relative to regulatory requirements. Bio-Medical Devices Intl, Inc. does not recommend the appropriate systems for a particular institution or facility.

DO NOT use if any component is damaged. If any components are damaged or contaminated and therefore unfit for safe and effective use, they should be replaced immediately.

Use only MAXAIR Systems/ NIOSH approved compatible components.

The DLCs are not intended for use against oily particulates such as paint mist, oil mist or detergents.

NOT for use in atmospheres immediately dangerous to life or health (IDLH), and atmospheres containing less than 19.5% oxygen.

Follow current local regulations governing biohazard waste to safely dispose of used shrouds.

If you need more information, contact your BMDI Sales Representative, or call BMDI customer service at 1-800-443-3842.

Intended Use

The MAXAIR® eCAPR Shroud Systems are intended to filter aerosolized and droplet particulates.

Shrouds are designed for single use applications.

For Use With

The MAXAIR 2264-01 DLC-Shroud is a component of the MAXAIR eCAPR Shroud Systems and is intended to be donned with a MAXAIR eCAPR Powered Air Purifying Respirator (PAPR) 2079-03 Helmet and a 2167-10 Filter Cartridge.

Standard eCAPR-37 System with 2264-01 DLC Shroud



1. 2079-03 Helmet (with 2071-05 Liner and 2590-05 Power Cord and with the 2051-07 SnapOn Cage removed)	5. 2167-10 Filter Cartridge
2. 2500-37TSC Battery*	6. 2061-08 Filter Cover Cap
3. 2000-76 Battery Belt	7. 2264-01 DLC Shroud***
4. 2600-02 Battery Charger**	

* Alternate Batteries include the 2500-36TSC 2500-30TSC.

** Alternate Charger includes the 2600-01.

*** Alternate Shrouds include the 2260-05 ML and SM.

Materials

DLC Lens is PETG
 DLC Cuff is Polyurethane
 Shroud body is Polypropylene

Specifications

Temperature Limits: 49°C
 Efficiency Rating: HE

Regulatory

NIOSH

Assembly



NOTE

Instructions are the same if using the P/N 2260-05ML and 2260-05SM



WARNING

Start with the ML size for medium to large head sizes; the SM is for very small head sizes.



1. Remove Shroud from packaging; note Shroud is turned inside-out to mount to Helmet.



2. Grasp top of DLC Cuff and pull gently away from Lens so that Cuff and Flappers are away from Lens.

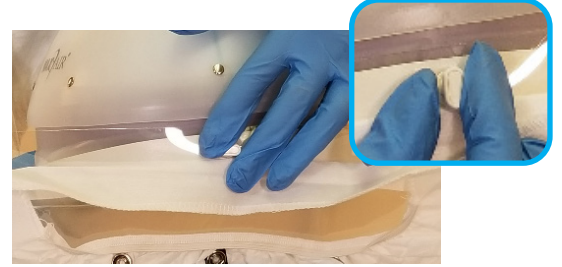

3. Turn FCC front TurnClip horizontal and attach Shroud front Mounting Hole over TurnClip. Turn TurnClip vertically to secure the attachment.



4. Pull Shroud top fabric up over the front TurnClip and tuck it in under and/or close to the FCC bottom edge all around FCC.



5. Snap one side of DLC onto one side FCC Attachment Post; then snap other side.



6. Hold helmet securely, grasp Shroud's rear Pull Tab and pull shroud up and over helmet.



7. Pull Shroud over and down the back of the Helmet.

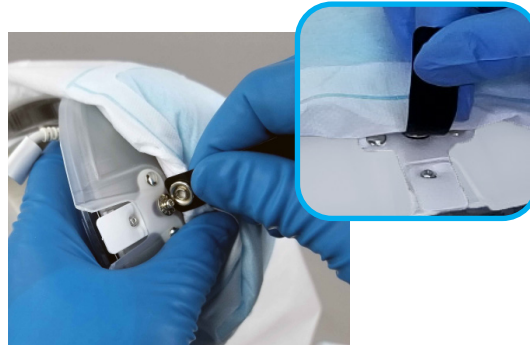

8. Use Pull Tap to position Shroud Rear Snap over FCC Rear Snap; snap and secure.



9. Snap and secure left Rear Side Snaps between Shroud and FCC. Then repeat on right Rear Side Snaps.

Disassembly

Reverse Assembly steps to remove Shroud from Helmet.



WARNING

Dispose of contaminated Shrouds according to institutional protocol for contaminated waste.

Donning



1. Assemble the Battery onto the Belt - Place top edge of Belt under Battery Clip; move Belt fully under and up to top of Clip. Then Don by placing belt comfortably around waist with battery near the side-back of the right hip.



2. Connect Helmet Power Cord to Battery; push Power Cord Connector into the Battery Receptacle until the Secure Connection audibly clicks.



3. Loosen headband Ratchet Knob (counterclockwise).

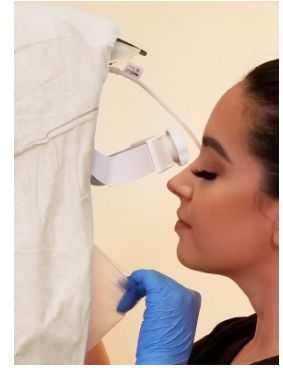

4. Pull top of DLC Cuff down to insert chin while pulling Helmet over and down on head.



5. Tighten Ratchet Knob secure as comfortably possible, while ensuring stability.

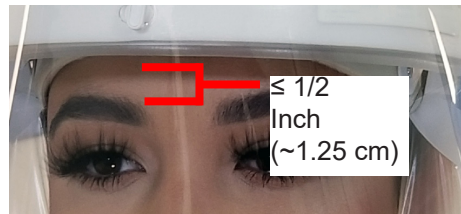

6. Position front headband within 1/2 inch of eyebrows for visualization of the Safety LEDs.



7. Pull back of shroud up and over the Helmet. Slide fingers between face and cuff on both sides from chin to temples to ensure slight Cuff-to-Face tension.



WARNING

After donning, if conditions 1 and 2 both are not achieved, switch to the other size DLC and repeat the Assembly and Donning steps to this point.



FCC Side Tabs
DLC Flappers

Condition 1: Ensure the DLC Flappers are away from the Lens, positioned perpendicular to your temples, and in front of the FCC Side Tabs.

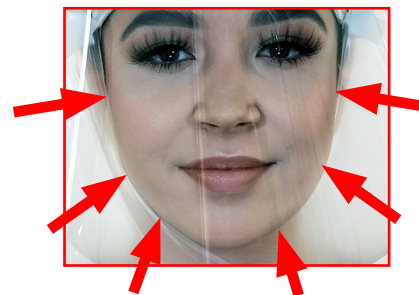

Condition 2: Ensure slight tension on the cuff is felt continuously while sliding the index or first finger between the cuff and the face all along the chin and up to the temples, from the right side of the face to the left.

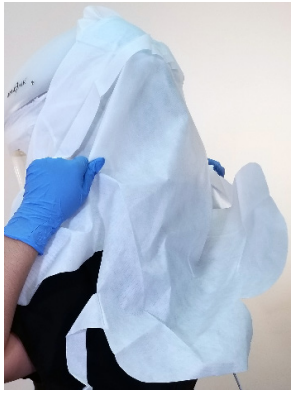

8. Continue pulling Shroud down all around.



9. Don outer body gown under the shroud per gown manufacturer's instructions.



10. Pull neck ties around to the front and tie securely, leaving about a 1/2 inch gap between neck and Shroud. Pull waist ties around and tie in front.

Doffing

Reverse steps 8 thru 14 to doff Helmet and remove Shroud. After disconnecting the Battery from the Helmet, connect it to the Charger.



WARNING

Refer to Section 9, for details on chargers and charging batteries.

16. 2271PS-07SM DLC Hood



CAUTION

Before use, thoroughly read MAXAIR® CAPR® P/N 03521015 User Instruction (received with all CAPR Helmets and available at www.maxair-systems.com.)



P/N 2271PS-07SM
(Small-Medium)
REF 07831244

P/N 2271PS-07ML
(Medium-Large)
REF 07831245

Note: One each 2172-97 HLF Pre-Filter is packaged with each 2271PS-07 Hood



Intended Use

The MAXAIR CAPR Hood Systems filter aerosolized and droplet particulates when used with a MAXAIR CAPR Powered Air Purifying Respirator (PAPR) Helmet.

Hoods are designed for single use applications.

Standard CA-CAPR-36 System with 2271PS-07 DLC Hood



Symbol Definitions



Warning, Caution, or Note



Part Number



NIOSH Number



WARNING

Failure to follow User Instructions P/N 03521015 and the instructions contained herein may be hazardous to the user's health.

Use only if package is received unopened and contents are undamaged. If damage is noted, contact the shipper for replacement or repair.

Prior to using any MAXAIR® System or component, be sure to be familiar with the system's NIOSH approved configuration.

DO NOT use if any component is damaged. If any components are damaged or contaminated and therefore unfit for safe and effective use, they should be replaced immediately.

Only trained and experienced personnel who have read and understand the User Instructions should use MAXAIR Products.

The institution using this product in any application is responsible for determining the appropriateness of this equipment relative to regulatory requirements. Bio-Medical Devices Intl, Inc. does not recommend the appropriate systems for a particular institution or facility.

Use only MAXAIR Systems/ NIOSH approved compatible components.

NOT for use in atmospheres immediately dangerous to life or health (IDLH), and atmospheres containing less than 19.5% oxygen, or more than 25% oxygen.

Flammability Level I: fabric may burn if exposed to open flame.

Follow current local regulations governing biohazard waste to safely dispose of single use MAXAIR Products.

If you need more information, contact your BMDI Sales Representative, or call BMDI customer service at 1-800-443-3842.

1. 2079-03 Helmet (includes 2051-07 SnapOn Cage, 2071-07 Liner, 2590-05 Power Cord)	2. 2271PS-07 Hood w/2172-97 HLF*
4. 2500-36TSC Battery**	3. 2061-05 HFR FCC
6. 2600-02 Battery Charger***	5. 2000-76 Battery Belt

*One 2172-97 (03731006) HLF is included with each Hood
 **Alternate Batteries include the 2500-37TSC and 2500-30TSC.
 ***Alternate Charger includes the 2600-01.

Specifications

MATERIAL	TYPE
Body (Shroud)	Polypropylene/Polyethylene
Lens	Polycarbonate
Hood Filter	Polypropylene
HLF PreFilter	Fully Synthetic Media

Recommended System Temperature Limits

Use/Handling: 0°C to 54°C at a maximum 80% Relative Humidity.
 Charging: 0°C to 45°C at a maximum 80% Relative Humidity.
 Storage: 0°C to 35°C at a maximum 80% Relative Humidity.

Regulatory

NIOSH HE

Assembly and Donning - Battery, Belt, Helmet and Hood



NOTE

Assembly of Hood to Helmet may be done prior to donning the Helmet or after. Always start with the ML size unless the user has a very small head size.

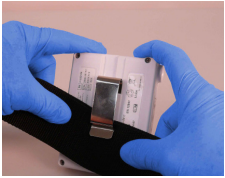

1. Assemble the Battery onto a double layer of Belt. Place top edge of Belt under the Battery Clip, up to the Clip top, so the Clip Detent rests on the Clip Base and NOT the Belt. Place the belt comfortably around the waist with the battery near the side-back of the right hip.



2. Connect Helmet Power Cord to Battery. Push Power Cord Connector into Battery Receptacle until Secure Connection audibly clicks.

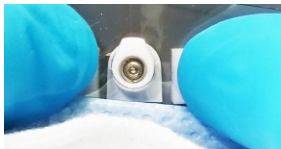

3. Attach (snap) center Hood-Lens mounting hole over Helmet center mounting post.



4. Gently pull Cuff and Flappers away from Lens to ensure they are not stuck together.

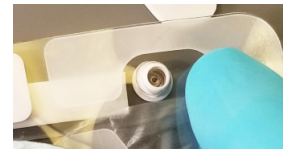

5. Attach (snap) one side Hood-Lens mounting hole to respective Helmet side mounting post. Repeat on other side.



6. Grasp the back of the Hood Filter and begin to pull the Hood up and over the Helmet.



7. Continue pulling the Hood over the Helmet down to within about 1-2 inches from the top rear Helmet Snap.



8. If the Hood Filter is folded over the front Velcro Strip, pull the Hood down further in back to remove the wrinkles.



9. Ensure the Cuff Flappers are away from the Lens and in front of the Liner Side Tabs.



10. Loosen the ratchet adjustment knob counter-clockwise to ensure the Helmet will easily fit over the head.

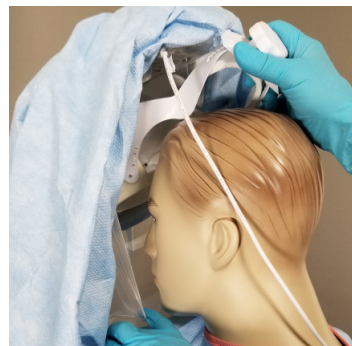

11. Hold the Helmet in one hand, pull the front top edge of the Cuff down, and place your chin into the Cuff. Then, pull the Helmet over and down on to your head.



12. Slide fingers between Cuff and face from temples to under chin to pull Cuff Flappers away from Lens, and to properly position the Cuff around sides of face.

WARNING

If conditions 1 and 2 both are not achieved, switch to other size DLC and repeat Assembly and Donning steps 1-12.



FCC Side Tabs
DLC Flappers

Condition 1: Ensure the DLC Flappers are away from the Lens, positioned perpendicular to your temples, and in front of the FCC Side Tabs.



Condition 2: Ensure slight tension is felt while sliding the index or first finger between cuff and face all along chin and up to temples, from right side of the face to the left.

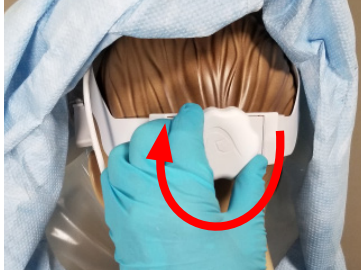

13. Tighten Ratchet Knob (clockwise) as tight as possible without causing discomfort to secure Helmet on head for all anticipated activities.

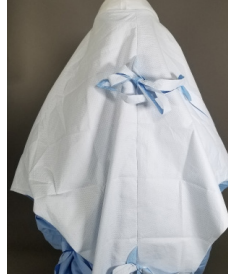

14. Pull Hood Shroud down all around.



15. Don appropriate body gown per gown manufacturer's protocol. Keep Hood Shroud up while closing gown so Hood is outside of gown.

Don HLF (NOT optional - Required per NIOSH Approval)



1. Initiate donning the HLF (Heavy Loading Filter) by tucking its back bottom up under back bottom of Helmet.



2. Complete by pulling HLF over and down, rear-to-front, of the Helmet and secure front bottom on Hood front Velcro strip.



3. Ensure Hood Skirt is fully down on all sides, secure neck ties to within about 1/2 inch of neck, and feed body ties through front hood shroud slits and tie securely.

Don HFR FCC (Optional High Fluid Resistance Filter Cover Cap - For Hood Filter protection against fluids)



1. Initiate donning the HFR FCC by placing it over the Helmet and aligning its front bottom center with the front bottom center of the HLF.



2. Using the thumb under the back bottom of the Helmet, pull the top back of the HFR FCC down onto the Helmet and HLF.



3. While holding the HFR FCC in place in front, continue pulling the it down in back until its back bottom is just below the back bottom of the Helmet.



4. Ensure the HFR FCC is fully down on all sides, fully covering the Hood Filter and HLF.

Doff HFR FCC (If it was donned)



1. While holding the HFR FCC front in place, begin lifting its rear bottom upwards.

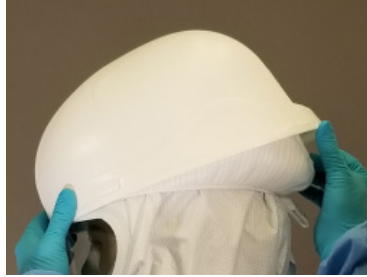

2. Continue lifting the HFR FCC rear bottom up and then forward until it is free from the HLF.

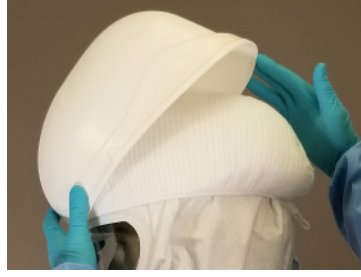

3. Lift the entire HFR FCC clear of the Helmet and clean/disinfect for next use.

Doff HLF



1. Begin HLF doffing by pulling its back bottom up over the Helmet back bottom.



2. Continue lifting the HLF up, forward, and off the Helmet and discard appropriately as contaminated waste,
or, ALTERNATIVELY,
temporarily leave it on and proceed to Doff with Hood (next section).

Doff the Hood, Helmet, Battery and Belt

WARNING
 Discard all disposables and body gown per Institutional protocol for contaminated waste.



1. Untie both neck and body Ties, pull through their loops, and discard appropriately as contaminated waste.



2. Lift Hood Filter off the Helmet Back (pull up with the HLF it is still on); then begin rolling Hood, inside over outside, from Hood Shroud back bottom up and over to top front of Helmet.



3. Unsnap each Hood side Flapper from the Helmet and continue moving the rolled Hood forward. Lift up and up to disengage the Hood Lens from the Helmet front Mount and lift entire hood forward and away. Discard appropriately as contaminated waste.



5. Loosen the rear Headband Adjustment Knob (turn counterclockwise).



6. Lift Helmet up and off head.



7. Unbuckle Belt and remove Battery and Belt from around the waste.

4. Doff body gown per manufacturer's and institutional protocol.

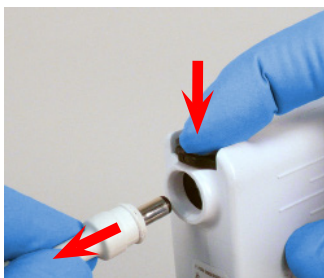

8. Disconnect the Helmet Power Cord from the Battery - Press down on the Secure Lock (Black) Button to release, then pull the cord connector out from the Battery connection receptacle.



9. With Charger connected to a safe power source, connect Charger Cord to the Battery. Push Charger Cord Connector into Battery Receptacle until fully seated.

WARNING
 Refer to Users Instructions (P/N 03521015) for details on chargers and charging batteries.



The entire CAPR System may be decontaminated, cleaned and/or stored at this time.

17. Hard Hat, P/N 2061-04A



P/N 2061-04A
(REF 01031528)

Symbol Definitions



Warning, Caution, or Note



Part Number



NIOSH Number



WARNING

Use only if package is received unopened and contents are undamaged. If damage is noted, contact the shipper for replacement or repair.

Prior to using any MAXAIR® System or component, be sure to be familiar with the system's NIOSH approved configuration.

DO NOT use if any component is damaged. If any components are damaged or contaminated and therefore unfit for safe and effective use, they should be replaced immediately.

Only trained and experienced personnel who have read and understand the User's Instructions should use this product.

Failure to follow the User's Instructions, these and in the MAXAIR Systems User's Instructions, P/N 03521015, may be hazardous to the user's health.

The institution using this product in any application is responsible for determining the appropriateness of this equipment relative to regulatory requirements. Bio-Medical Devices Intl, Inc. does not recommend the appropriate systems for a particular institution or facility.

Use only MAXAIR Systems/ NIOSH approved compatible components.

NOT for use in atmospheres immediately dangerous to life or health (IDLH), and atmospheres containing less than 19.5% oxygen, or more than 25% oxygen.

If you need more information, contact your BMDI Sales Representative, or call BMDI customer service at 1-800-443-3842.

Intended Use

The 2061-04A Hard Hat is part of a system intended to filter aerosolized and droplet particulates, and provide head and face protection.

For Use With

The Hard Hat is to be used with the MAXAIR Systems 2079-03 Helmet, the 2264-01 HH Shrouds and/or the 2366-02 HH Cuffs, 2167-10 Filter Cartridge, alternate Batteries, and an optional ANSI Z87.1 Lens, per table below.

FACE/HEAD COVER	FILTER CARTRIDGE
2264-01ML/SM DLC (Disposable Lens-Cuff) SHROUDS	2167-10
2366-01ML/SM DLC (Disposable Lens-Cuffs) CUFFS	

Standard eCAPR-37 System with 2061-04A Hard Hat and 2167-10 Filter Cartridge



1. 2061-04A Hard Hat	4. 2500-37TSC Li-Ion Battery*
2. 2167-10 Filter Cartridge	5. 2000-76 Battery Belt
3. 2079-03 Helmet with 2071-05 Liner and 2590-05 Power Cord, and with 2051-07 SnapOn Cage removed.	6. 2600-01 Battery Charger**

*The 2500-36TSC and 2500-30TSC are alternate Batteries.

**Alternate Charger is the 2600-01.

Alternate Face Seals, optional Lens and ChinStrap

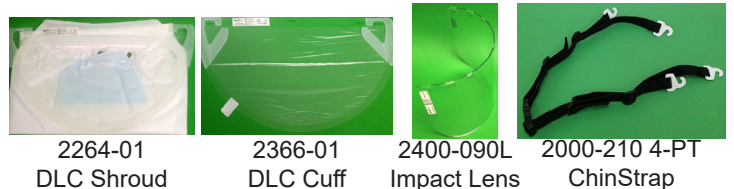

Specifications

Temperature Limits: 49°C

Materials

Hard Hat is glass filled Nylon

Regulatory

- NIOSH
- ANSI/ISEA Z98.1-2014 Type 1, Class G & C

Ready the Helmet for configuring it for use with the Hard Hat

The 2079-03 ships with a 2051-07 SnapOn Cage assembled as a shipping protector, a 2071-05 Liner, and a 2590-03 Power Cord.



NOTE

THE 2051-07 SnapOn Cage must be removed from the Helmet before a Filter Cartridge may be assembled to the Helmet.

Refer to Section 10, page 45, for instructions to remove the 2051-07 SnapOn Cage.

Assembly - Filter Cartridge to 2079-03 Helmet



WARNING

A Filter Cartridge must be installed on the Helmet before use;



Hold Helmet in one hand (A), lower the Filter Cartridge by its plastic retainer ring down onto helmet (B).

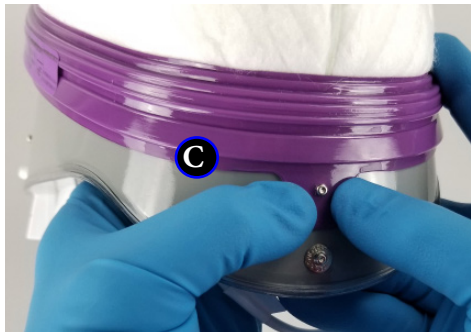

Snap rear Cartridge Tab to Rear Helmet Snap (C)



Snap each side Cartridge Tab to each side Helmet Snap (D). If necessary, press Retainer Ring down close to front Helmet Adapter (E) to get side Tabs over side Snaps (E).

Assembly - Liner (when necessary) to Helmet

To assemble the 2071-05 Liner on the Helmet refer to Section 11, page 46.

Assembly - Hard Hat to Helmet

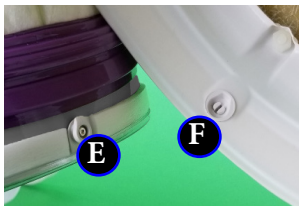

1. Locate Helmet front Mounting Adapter (E), locate Hard Hat front Mounting Hole (F).



2. Place Adapter into Mounting Hole (G).



3. Pull Hard Hat over and down on Helmet (H) until Hard Hat T-Tab (I) is over and snaps to lower rear Helmet Snap (J).



Disassembly - Liner, Hard Hat, and Filter Cartridge from Helmet

Disassembly is the reverse of Assembly steps immediately above.

Assembly - Face (DLC Cuff) or Headcover (DLC Shroud) to Assembled Hard Hat Helmet

DLC Shroud
(Disposable
Lens-Cuff
Shroud)

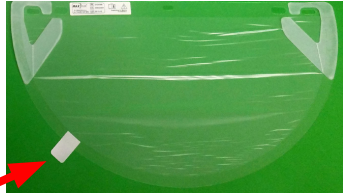

DLC Cuff
(Disposable
Lens-Cuff Cuff)



CAUTION

Before use, using the peel tab, be sure to remove the lens protecting film from the DLC Cuff Lens.

1. Remove Shroud/Cuff from packaging and lay on a clean surface with label facing up.



2. Securely attach one set of side Lens holes (2) over one side Hard Hat Turn Clip and Mounting Post. Secure Turn Clip vertically.



3. Securely attach the Lens center hole over the Hard Hat center Turn Clip. Secure Turn Clip vertically.

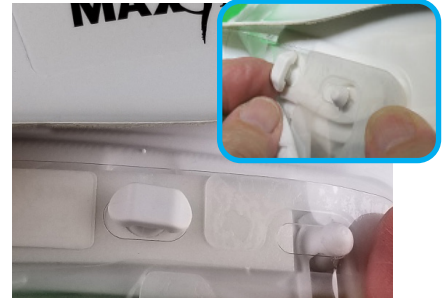

4. Securely attach other set of side Lens holes (2) over other side Hard Hat Turn Clip and Mounting Post. Secure Turn Clip vertically.

Assembly cont'd - SHROUD ONLY

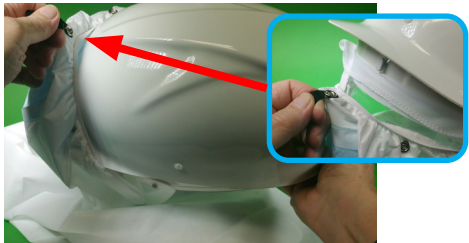

5. Use the black pull tab to pull the Shroud up over the Hard Hat front and back towards the rear.



6. Continue pulling Shroud over and down the back of the Hard Hat and snap to the T-Tab Snap.



7. Attach one side-rear snap of the Shroud to one side-rear snap on the Hard Hat, then repeat for the other side. This step completes the Shroud assembly.

Disassembly - Cuff and Shroud

Disassembly of the DLC Cuff is the reverse of Assembly steps 1-4, immediately preceding.

Disassembly of the Shroud is the reverse of Assembly steps 1-7, immediately preceding.

Assembly - ANSI Z87 Lens



1. Securely attach one set of side Lens holes (2) over one side Hard Hat Turn Clip and Mounting Post. Secure Turn Clip vertically.



2. Securely attach the Lens center hole over the Hard Hat center Turn Clip. Secure Turn Clip vertically.

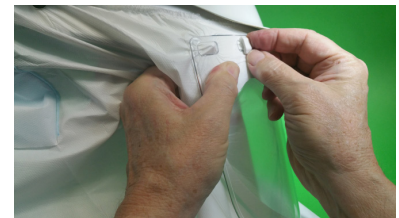

3. Securely attach other set of side Lens holes (2) over other side Hard Hat Turn Clip and Mounting Post. Secure Turn Clip vertically. This step completes Lens Assembly.

Disassembly - ANSI Z87 Lens (follows assembly of a Shroud or Cuff)

Disassembly of the Lens is the reverse of Assembly steps 1-3, immediately preceding.

Don - Cuff and Shroud



1. Loosen Headband Adjustment Knob (counterclockwise) to allow Helmet to fit over head.

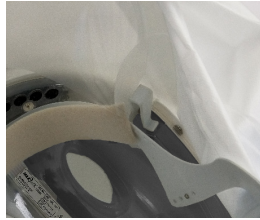

2. Ensure the Cuff Flappers are out away from the Lens and in front of the Liner Side Tabs.

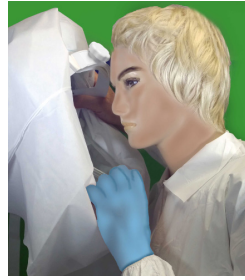

3. Pull top edge of Cuff down, insert chin into cuff and then pull Helmet over and down on the head.

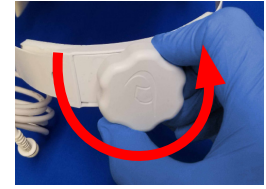

4. Turn Adjustment Knob clockwise to tighten Headband as tight as comfortable to secure Helmet to Head for all anticipated activities.



5. SHROUD ONLY - Pull all bottom edges of the Shroud fully down. Tie the neck ties to within about 1 inch of the neck; tie the body ties comfortably secure around the midsection.



Fully donned Hard Hat System with Shroud and ANSI Lens.



Fully donned Hard Hat System with Cuff and ANSI Lens.

DoFF - Cuff and Shroud

1. Reverse Don steps 1-5, immediately preceding.

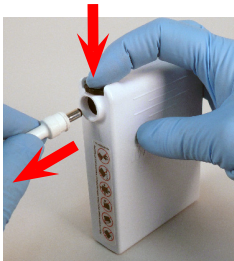

2. Disconnect the Helmet Power Cord from the Battery - push the Secure Connection Button down, pull Cord Connector out, release the Button. Connect the Battery to the Charger.



WARNING

Refer to Section 9, Instructions For Use: Charger, for details on proper use of chargers and for charging batteries.

18. Decontamination / Cleaning



CAUTION

Do not immerse the battery, helmet and fan module into water or other liquid. This will cause irreparable damage to the helmet.

Do not use solvent or alcohol to clean the helmet. Isopropyl alcohol may be used to clean the Helmet. However, repeated long term use of isopropyl alcohol may deface the Helmet.

Do not subject helmet to any sterilization cycles.

Do not use organic solvents or strong oxidizing agents to clean the helmet.

The air channels should never need cleaning. If they do, the Filters are not being maintained properly or replaced at the appropriate intervals.

If other cleaning agents are to be used, it is recommended to test their use on a small section of one DLC Lens and/or a small section of the Helmet Liner to determine short and long term side effects.

It is not recommended to disconnect the Power Cord from the Helmet. The Power Cord should be decontaminated and cleaned as part of the Helmet.

Decontaminating

Supplies Needed:	Frequency:	Accomplishes:
<ul style="list-style-type: none"> Decontaminating wipe Decontaminating Agent: Alcohol, bleach, or quaternary ammonia. 	<ul style="list-style-type: none"> Wipe between uses and between different users wearing the system. 	<ul style="list-style-type: none"> Reduces cross contamination. Extends useful life. Improves hygiene.
Procedure:		
1. Inspect the system and perform any assembly/disassembly instructions necessary for disposable items and for all components that have become worn or damaged.	2. Apply a suitable wipe with a decontaminating agent over all outside reachable surfaces, and then over all inside surfaces.	3. Let air dry and re-assemble or place in storage.



NOTE

If desired, replace the DLC, Helmet Liner, Filter Cartridge, or Filter Cover Cap by following their assembly and disassembly procedures.

Replace the Front Headband Comfort Strip with a new one.

The rear Closed Cell Foam comfort pad may be cleaned for reuse by wiping down the outer surfaces with a decontaminating wipe.

Cleaning

Supplies Needed:	Frequency:	Accomplishes:
<ul style="list-style-type: none"> Clean Damp Cloth Cleaning Agent: Mild application of skin friendly soap. 	<ul style="list-style-type: none"> Wipe between uses and between different users wearing the system. 	<ul style="list-style-type: none"> Reduces cross contamination. Extends useful life. Improves hygiene.
Procedure:		
1. Use a damp cloth with cleaning agent to clean all outer and inner exposed surfaces.	2. Let air dry.	



NOTE

If desirable, replace the damaged or soiled Front Headband Comfort Strip.

The rear Closed Cell Foam comfort strip may be cleaned for reuse.

19. General System Maintenance and Storage



CAUTION

Prior to each use, if any of the following issues are discovered for any system component(s), replace the particular item(s) by following the assembly/disassembly procedures for the particular item(s).

- Tears or Breaks.
- Contamination from blood or other bodily fluids not safely removed by following approved disinfection procedures.
- Compromise between the DLC and FCC seal.
- Damage or distortion to the filter cartridge gasket.
- Filter is soiled or challenged with particulates such as to compromise its performance or cause the yellow LED to be lighted.
- Compromise between the filter cartridge and helmet seal.
- Any other damage and threat to proper function.



NOTE

The complete MAXAIR eCAPR System and all components and accessories should be stored indoors in a safe, clean and secure environment at all times, protected from adverse environmental conditions, i.e. conditions that would be considered incompatible with normal human working conditions without special equipment.

General System and Component Storage Environment

Temperature/ Humidity

Temperature: -20° C to +40° C

Maximum Humidity: 80% Relative Humidity.

Helmet Liner

- If the Helmet Liner is loosened after repeated assembly/disassembly so as to compromise its attachment mechanism or causes the Helmet mounting to be unstable and if there are any tears or breaks in the Liner, the Helmet Liner should be replaced by following its assembly and disassembly procedure.
- The Liner Power Cord Slot allows removal and attachment of the Liner without removal of the Power Cord.

Helmet

- If the Helmet is damaged or operating improperly, do not attempt repair. Contact Customer Service, 1-800-443-3842 for the return procedure for evaluation and possible repair or replacement.

Helmet Power Cord

- If the Helmet Power Cord connectors and cord insulation appear damaged in any manner, and if any cord wire is exposed, replace with a cord in good working condition. Grasp the cord connector firmly and turn it until its notch is aligned with the Helmet cord connector slot, then pull the cord connector straight up and away from the helmet. Replace with a new cord by aligning the Cord connector notch with the Helmet connector slot, insert the Cord connector into the Helmet connector, and turn the Cord towards the rear of the Helmet to secure it in place.

Filter Cartridge

- If the Filter is soiled or loaded (clogged) with particulate such as to compromise its performance or cause the Yellow LED to be lighted, or if there are tears or breaks, or if there are compromises between the seal and the Helmet, or any other damage, the Filter Cartridge should be replaced by following the assembly and disassembly procedures for the FCC and the Filter Cartridge.

- Particular attention must be made to inspection of the Filter Cartridge (black) Gasket for any damage that could adversely affect its seal with the Helmet. If there is any damage or doubt regarding the seal, replace the Filter Cartridge.

Filter Cover Cap (FCC)

- The FCC must be inspected before each use. If the FCC is loosened after repeated assembly/disassembly such as to compromise its attachment mechanism or causes the Helmet mounting to be unstable, or if it has tears or breaks, the FCC should be replaced by following its assembly and disassembly procedures.

Disposable Face and Head Covers: DLC Cuffs and Shrouds

- The DLC Line of Face and Head Covers is designed for single use, once on/once off the Helmet. Repeated assembly and disassembly will compromise the attachment mechanism or cause the Helmet mounting to be unstable. The DLC items should be discarded as contaminated waste after removal from the system and replaced by following the appropriate item assembly and disassembly procedures in this User's Instructions and the individual Instructions For Use.
- If there are any tears or breaks or fluid penetration in the DLC items, or any issues with the visual clarity of the Lenses, the DLC item should be replaced by following the appropriate assembly and disassembly procedures.

Battery

- MAXAIR Systems Li-Ion Batteries are designed to be maintenance free. If a battery has any damage or malfunction, contact Customer Service at 1-800-443-3842, for an RMA (Return Material Authorization) for evaluation and possible replacement.
- Also refer to the next section, Battery Use and Maintenance, for additional instructions regarding Batteries.



Do not drop



Do not puncture.



Do not immerse in liquid.



Do not attempt to disassemble, open, or service.



Do not place near or in a flame.

Battery Charger

- MAXAIR Systems Battery Chargers are designed to be maintenance free. If a charger has any damage or malfunction, contact Customer Service at 1-800-443-3842, for an RMA (Return Material Authorization) for evaluation and possible replacement.



Do not drop



Do not puncture.



Do not immerse in liquid.



Do not attempt to disassemble, open, or service.



Do not place near or in a flame.

20. Battery Use, Maintenance and Storage



CAUTION

Do not store batteries for more than three months without subjecting them to normal discharge and recharge cycling. Ideally, batteries not being used routinely on a less than monthly frequency should be charge-cycled every three months, minimum.
Optimal storage for Lithium Ion batteries is at 50% charge and approximately 0°C-10°C.



CAUTION

MAXAIR Systems Lithium Ion (Li-Ion) batteries (LIBs) are secondary (rechargeable) batteries, not primary (storage) batteries.

MAXAIR Systems Li-Ion Batteries (LIBs) hold much of their charge for a year or longer. However, as with all rechargeable batteries, the amount of charge will decline slowly in use or storage (*self-discharge rate*), depending on time and temperature, and the maximum *recoverable charge* level diminishes gradually over the life of the battery.

20.1 Routine Infection Control use in med/surg and ED areas

- If LIBs are being used more than once per month, they should be connected to chargers in between uses.
- Before each use, physically inspect the LIB. If you perceive physical damage or tampering, use a different MAXAIR LIB and replace the damaged LIB as soon as possible.
- Routinely, every 3-6 months, perform the “LIB Check Procedure” (see Section 19.3.7). If this procedure results in a “Suspect LIB”, use a different MAXAIR LIB and replace the Suspect LIB as soon as possible.
- Check LIBs that are connected to MAXAIR chargers on a daily basis. If the charger LED is green, the LIB is ready for use and should be disconnected from the charger.



CAUTION

Check LIBs connected to chargers on a daily basis.

If a LIB is warm-to-hot to the touch, disconnect the LIB from the charger and replace it immediately. If this condition is ever observed, please mark the specific battery and the specific charger it was connected to when the heating was noted, and contact us for replacement. Call Customer Service, 1-800-443-3842, for return and replacement instructions.

If the charger LED is Green, the LIB is fully charged and ready for use, therefore disconnect if from the charger. DO NOT leave the LIBs on the chargers after the charger LED turns Green.

20.2 Emergency Preparedness (EP) and In-Frequent Use

- MAXAIR batteries are shipped to customers at the 50% charge level (approximately 14.6v output level). This is the approximate level recommended for long term storage of a Li-Ion batteries, and therefore what we recommend for EP use to achieve the longest overall useful life of the batteries.
 - For a new 2500-37TSC battery this represents up to 6 hours of use before recharging to a fully charged level.
 - For a new 2500-36TSC battery this represents up to 4 hours of use before recharging to a fully charged level
- For systems that may be in storage and not used for longer than a year, the battery charge should be revalidated every 3-6 months, minimum.

20.3 General Use, Maintenance, and Storage



WARNING

Failure to read and follow these instructions and guidelines may result in fire, personal injury and damage to property. Your MAXAIR LIBs need to be handled/transported, used/discharged, charged, and stored properly. Follow the safety rules listed below.

Follow these instructions and the Instructions For Use (IFU), and use MAXAIR LIBs in accordance to the warning labels on the MAXAIR LIBs to properly manage and control charging and discharging of all MAXAIR LIBs.

1. Keep MAXAIR LIBs and Chargers away from children.
2. Test MAXAIR LIBs before using to ensure they are operating properly and safely with the MAXAIR Helmet or on the MAXAIR Charger. (see Section 19.3.7).
3. As with all Li-Ion battery packs, misused and defective Li-Ion cells may explode and cause fire. If at any time a LIB starts to balloon, swell up, smoke or get hot, emit an unusual smell, change color, or appear abnormal in any other way, discontinue its use immediately, disconnect the LIB from the Helmet or Charger, and observe it in a safe place for approximately 15 minutes. If any of these conditions occur, the LIB should be replaced.



CAUTION

These conditions may result in LIB cell leakage. Since delayed chemical reaction can occur, it is best to observe the LIB as a safety precaution in a safe area outside of any building or vehicle and away from any combustible material. In the event of coming in contact with any leakage from a LIB, do not rub or touch the eyes, immediately rinse all contacted areas thoroughly with water, and immediately seek medical care. If left untreated, the LIB leakage could cause eye and other serious injury.

4. In the event of any damage or perceived damage to a LIB due to bad shipment or other reason, remove the LIB to a safe location for observation and place it in a safe open area away from any combustible material for approximately 15 minutes.
5. Do not place LIBs in direct sunshine, or use or store LIBs inside relatively closed environments (cars, etc.) in hot weather and anywhere extreme temperatures may exist. Doing so may cause the LIB to generate heat, rupture, or ignite. Using the LIB in this manner may also result in a loss of performance and a shortened life expectancy.
6. Do not use, charge or store LIBs in or near microwave ovens, high pressure containers, or conduction cookware.
7. Do not expose a LIB to water, salt water, any other liquid, or moisture, beyond air with a relative humidity between 10%-90%.
8. Do not connect the connection terminals together, even momentarily, with any material including touching with the human body.
9. Do not allow a LIB to make contact with a hard object (dropping, throwing, striking, piercing, etc.) so as to subject it to strong impact, shock, or other mechanical stress.
10. Do not open, penetrate, or attempt to disassemble or modify a LIB case in any manner without contacting the manufacturer. The LIB contains safety and protection devices which, if damaged, may cause the LIB to generate heat, rupture, or ignite.
11. Do not submit to static electricity.

20.3.1 Recommended Temperature Ranges

Degrees Centigrade		Degrees Fahrenheit		Activity
min.	max.	min.	max.	
0	54	32	129	Handling & Transporting
0	54	32	129	Use/Discharging
0	45	32	113	Charging
0	35	32	95	Storage

If recommended temperature range is exceeded, let batteries cool down or warm up, as appropriate, to ambient temperature, and ensure all condensation, if any, has evaporated before charging or use.

20.3.2 Use/Discharge

**WARNING**

Do not discharge a LIB by using any device except a MAXAIR Helmet.

The temperature range over which a LIB is to be discharged is 0° C-54° C (32° F-129° F). Use outside of this temperature range may damage the performance and reduce the life expectancy of the LIB.

**CAUTION**

When the LIB has reached its usual and customary useful life (See 19.3.6) -

Immediately discontinue use of the LIB and replace it.

Insulate the connection terminals with adhesive tape or similar material before disposal.

20.3.3 Charge

**WARNING**

Always use a MAXAIR charger when charging a LIB; never use any other type of charger for a MAXAIR LIB.

Never connect a LIB to any device other than a MAXAIR helmet or a MAXAIR charger.

Never charge a LIB outside the temperature range of 0° C to 45° C (32° F to 113° F). Charging the LIB at temperatures outside of this range may cause the battery to become hot or damaged. Charging the LIB outside of this temperature range may also harm the performance of the LIB or reduce the LIBs life expectancy. When the LIB becomes hot, the built-in safety equipment is activated, preventing charging further. Additional heating can destroy the safety equipment and can cause accelerated temperature increases, ignition, or other damage to the LIB.

Do not continue charging the LIB if it does not recharge within the maximum charging time. (See 19.3.8) Doing so may cause the LIB to become hot, rupture, or ignite.

Always charge in an isolated area, away from flammable materials.

When charging LIBs, always monitor the charging process and react to potential problems that may occur.

20.3.4 Store

**WARNING**

Store in closed containers and packaging that prevent short circuits and damage during storage or transportation.

In case of mixed storage of goods and articles, organize separate storage areas for LIBs, for example, by maintaining a distance of 2.5 meters between the LIB storage area and other goods.

Store in limited quantities and in isolated area with frequent surveillance.

Keep in a dry, cool and well-ventilated place, within the recommended storage temperature range of 0° C-35° C (32° F-95° F). Cooler and dryer environments of storage are safer and extend useful life.

The temperature range of 19° C-25° C (66° F-77° F) at 30%-50% full charge will optimize battery useful life.

Perform a boost charge and LIB Check Procedure (Appendix B.) every 3 to 6 months; this will help prevent the potential of an over-discharge.

20.3.5 Handling and Transport

Lithium-Ion batteries are classified as Dangerous Goods for the Transport by Road/Rail, Sea and Air. When considering transporting LIBs to other locations, conform to the requirements of the UN Regulation on the Transport of Dangerous Goods.

Internal transfer of Lithium-Ion batteries should follow the minimum safety rules imposed by the local legislation/regulation regarding the handling of Dangerous Goods.

When handling LIBs, use caution, specifically to avoid shorting the connector terminals.

**WARNING**

Do not exceed the temperature range of 0° C-54° C (32° F-129° F) when handling and transporting LIBs.

Do not expose battery packs to direct sunlight and/or heat for extended periods.

20.3.6 Useful Life

Li-Ion batteries begin aging when they are manufactured - not when you begin using the battery. Lithium-Ion batteries are prone to aging somewhat rapidly. The useful capacity (Recoverable Capacity) of a Lithium-Ion battery decreases about 10% to 20% each year. Therefore, Lithium-Ion batteries have a useful aging-service life of approximately four years.

Li-Ion batteries have a useful capacity-service life of 300-500 cycles (one cycle being the time of one full use from a full charge).

Therefore, the recommended useful life expectancy, or replacement schedule, for a Li-Ion battery is after four years or 300-500 discharge cycles, whichever occurs first.

20.3.7 LIB Check Procedure - MAXAIR LIB Test for Diminishing Battery Capacity



NOTE

A MAXAIR helmet and MAXAIR charger are required to perform this basic battery test. The helmet and power cord must be in good working order. Set the helmet Air Flow Switch to Low for the test.



CAUTION

If the LIB performs in one of the "Suspect LIB" categories below, discontinue using it and replace that LIB as soon as possible.

Case 1: The LIB has been connected to a charger and the charger green LED is on.

Procedure: Unplug the LIB from the charger and plug the helmet power cord to the LIB. Allow the helmet to settle for about 10 seconds.

Good LIB: The helmet runs with 3 or 2 green indicator lights on.

Suspect LIB: The helmet runs with only 1 green indicator light on.

Suspect LIB: The helmet runs with the red indicator light on.

Suspect LIB: The helmet doesn't run.

Case 2: The LIB has been in storage.

Procedure: Plug the helmet power cord to the LIB to be tested. Allow the helmet to settle for about 10 seconds.

Good LIB: The helmet runs with 3, 2 or 1 green indicator light on.

Suspect LIB: The helmet runs with the red indicator light on.

Suspect LIB: The helmet doesn't run.

Case 3: The LIB is connected to the MAXAIR Charger.

Good LIB: the LIB is felt to be about room temperature.

Suspect LIB: the LIB is warm or hot to the touch.



20.3.8 Reference Information

Typical Charging Time Specifications:

Time to fully charge a fully discharged MAXAIR LIB

CHARGING TIME		
BATTERY	2600-01 (01432089) Charger	
	Typical	Maximum
2500-37TSC (01532161)	3.8 hrs	7.5 hrs
2500-36TSC (01532104)	2.5 hrs	5.0 hrs

Lithium-ion Battery main components:

MSDS for Li-Ion Battery Cells available upon request. Call Customer Service, 1-800-443-3842.

20.3.9 Charging Protection from Electrical Surges

It is highly recommended to always connect the MAXAIR Charger directly to a Surge Protection Device, adequate for all anticipatable occurrences, during all charging activities of MAXAIR LIBs, and whenever the Charger is connected to a mains power source.

To choose an appropriate surge protector you should consult with your Engineering department regarding specifics to your physical plant and geographical environment. You may want to consider the following common fundamentals of surge protection:

To choose an appropriate surge protector you should consult with your Engineering department regarding specifics to your physical plant and geographical environment. You may want to consider the following common fundamentals -

- ▲ Indicator light – surge protectors will not last forever – when a surge protector properly diverts a surge, the protector itself can be damaged in the process. An indicator light will indicate that the surge protector is working fine.
- ▲ UL Rating - good surge protectors come with a UL rating (or equivalent regulatory mark for non U.S. countries, e.g. CE Mark, etc.), a rating put out by the independent Underwriters Laboratories that tests the safety of electronic devices.
- ▲ Clamping voltage - the voltage measurement that prompts the surge protector to start redirecting the excess electricity away from the plugged-in devices.
- ▲ A surge protector with a lower clamping voltage will trigger earlier, thus better protecting electrical devices.
- ▲ Joule rating - the maximum amount of energy the surge protector can absorb. If the surge exceeds this maximum, the surge protector will be rendered useless. The higher the joule rating, the more energy can be absorbed by the surge protector, therefore, a higher joule rating will often indicate a longer lifespan for the product.

20.3.10 Projected LIB Level Available As A % At Initial Manufacture Versus Temperature

Year(s) Elapsed from Manufacture Date	Storage Condition: 50% charged				Storage Condition: 100% charged			
	Residual Capacity (due to Self- Discharge)		Recoverable Capacity		Residual Capacity (due to Self- Discharge)		Recoverable Capacity	
	23°C	60°C	23°C	60°C	23°C	60°C	23°C	60°C
1	96%	76%	99%	92%	90%	60%	94%	80%
2	92%	52%	98%	84%	80%	20%	88%	60%
3	88%	28%	97%	76%	70%	0%	82%	40%
4	84%	4%	96%	68%	60%	0%	76%	20%
5	80%	0%	95%	60%	50%	0%	70%	0%
Year(s) Elapsed from Manufacture Date	Self-Discharge Loss		Permanent Capacity Loss		Self-Discharge Loss		Permanent Capacity Loss	
	23°C	60°C	23°C	60°C	23°C	60°C	23°C	60°C
	1	4%	24%	1%	8%	10%	40%	6%
2	8%	48%	2%	16%	20%	80%	12%	40%
3	12%	72%	3%	24%	30%	100%	18%	60%
4	16%	96%	4%	32%	40%	100%	24%	80%
5	20%	100%	5%	40%	50%	100%	30%	100%

20.3.11 Glossary

LIB

Lithium Ion Battery, Li-Ion Battery

Self Discharge

The rate at which the battery charge level declines while it is just sitting in storage, usually quoted as a decline in %-per-month.

Self-discharge increases with age, cycling and elevated temperature.

Discard a battery if the self-discharge reaches 30 percent in 24 hours.

Recoverable Capacity

The amount that a battery can be “fully charged back to” over time, usually quoted as a certain % of the full charge level when the battery was initially manufactured.

21. Disposal



WARNING

Dispose of potentially contaminated disposable components, DLCs, DLC-Shrouds, Filter Cartridges, etc., in accordance with approved institutional protocol for medical waste and current local regulations.



Lithium-Ion Rechargeable Batteries contain toxic chemicals and must be disposed of following current local regulations, and your local recycling program. Additional information may be found at earth911.com and ecyclingcentral.com.



Helmets and Battery Chargers contain electronic components and must be disposed of following current local regulations, and your local recycling program. Additional information may be found at earth911.com and ecyclingcentral.com.



22. Accessories and Alternate/Replacement Parts



Storage Accessories

#	CATALOG NUMBER (NIOSH NUMBER)	Description	QTY		#	CATALOG NUMBER	ITEM	QTY
1	2000-204	Helmet Hooks	6/pkg		3	2782-06	Cart	1/Box
2	2000-SB	System (Carry) Bag	1/Box					
								

Helmets, Peripherals, Accessories

#	CATALOG NUMBER (NIOSH NUMBER)	Description	QTY	
1	2079-03 (● 03531214 Helmet ● 01031269 Cage ● 03531021 Liner ● 2590-05 Power Cord)	eCAPR Helmet Assembly	1/Box	
2	2071-05 (03531148)	Liner for 2079-03	1/Box	
3	2061-08 (01031284)	Filter Cover Cap (FCC) for 2079-03 with SnapOn Cage removed	3/Box	
4	2061-04A (03531152)	Hard Hat	1/Box	
5	2051-07 (01031269)	SnapOn Cage	3/Box	

Helmets, Peripherals, Accessories

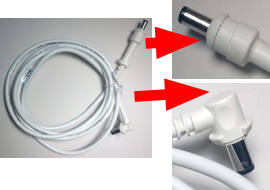
#	CATALOG NUMBER (NIOSH NUMBER)	Description	QTY	
6	2000-209	Rear Liner-Headband Comfort Strip (Closed Cell Foam)	5/Box	
7	2000-201	Front Liner-Headband Comfort Strips	36/box	
10	2590-05	Long Power Cord (59")	1ea	

Assembly of 2590-05 Power Cord to Helmet

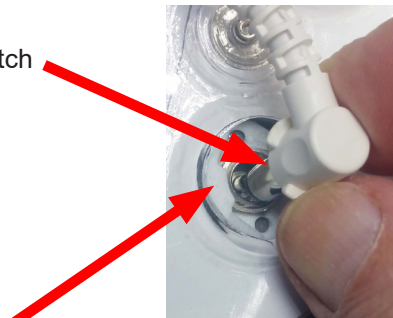

Cord Notch

Helmet Connector Tab



1. Align Cord notch with Helmet connector tab.
2. Push Cord connector fully to bottom of Helmet connector.
3. Turn Cord towards back of Helmet to secure the connection.

Disassembly of 2590-05 Power Cord from Helmet





1. Align Cord notch with Helmet connector tab.
2. Lift Cord connector up and away from Helmet.



Filter Cartridges vs. Battery Compatibility

#	CATALOG NUMBER (NIOSH NUMBER)	Description	QTY	Filter Cartridge	Batteries to Use With Filter Cartridge	
					2500-37TSC	2500-36TSC
1	2167-10 (01031569)	XP Filter Cartridge	3/Box			

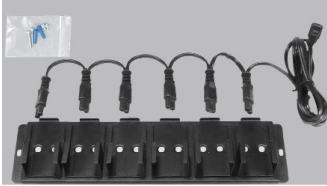
Chargers

#	CATALOG NUMBER (NIOSH NUMBER)	Description	QTY	
1	2600-01 (01432089)	Battery Charger	1/box	
2	2600-02 (01432202)	Battery Charger	1/box	
3	2602-06 Gang Charger includes six 2600-02 Chargers	6 Gang Charger	1/box	
4	2602-06B Gang Charger Bracket accommodates up to six 2600-02 Chargers, purchased separately	6 Gang Charger Bracket	1/box	

Batteries and Belts

#	CATALOG NUMBER (NIOSH NUMBER)	Description	QTY	
1	2500-36TSC (01532104)	Li-Ion Battery 4 Cell	1/Box	
2	2500-37TSC (01532161)	Li-Ion Battery 4 Cell	1/Box	
4	2000-76	Battery Belt	1/Box	

Face Seals and Head Covers

#	CATALOG NUMBER	Description	QTY	
1	2366-02SM (01031556)	DLC Cuff, Hard Hat - Small/Medium	40/Box	
2	2366-02ML (01031555)	DLC Cuff, Hard Hat - Medium/Large	40/Box	
3	2365-02SM (01031316)	DLC Cuff, Small/Medium	40/Box	
4	2365-02ML (010311291)	DLC Cuff, Medium/Large	40/Box	
5	2264-01SM (01031562)	DLC Shroud, Hard Hat - Small/Medium	20/Box	
6	2264-01ML (01031565)	DLC Shroud, Hard Hat - Medium/Large	20/Box	
7	2260-05SM (01031435)	DLC Shroud, Small/Medium	20/Box	
8	2260-05ML (01031434)	DLC Shroud, Medium/Large	20/Box	
9	2271PS-07SM (07831244)	DLC Hood, Small/Medium		
10	2271PS-07ML (07831245)	DLC Hood, Medium/Large		

23. Specification

Specifications listed are approximate and may vary slightly from unit to unit or by power supply fluctuations and/or tolerance of the controller.

eCAPR SYSTEM		
#	PROPERTY	SPECIFICATIONS (NIOSH)
1	Complete Device Classification	PAPR, Loose Fitting
2	89/686/EEC Complete Device Category	N/A
3	93/42/EEC Complete Device Class	N/A
4	EMC Classification (IEC 60601-1-2: 2007; EN 60601-1-2:2007)	N/A
5	Storage Temperature Range	-
6	Storage Maximum Humidity	-
7	Effective field of vision versus natural field of vision	N/A
8	Overlapped Field of vision versus natural field of vision	N/A
9	Maximum Inward Leakage	N/A
10	Fit Factor	Minimum 500
11	Maximum allowable Percent Leakage: Dioctyle-Phthalate Test	0.03% @ 107 LPM
12	Minimum allowable NaCl efficiency	99.97% @ 125 lpm
13	Maximum Breathing Resistance	N/A
14	Minimum Airflow	170 LPM
15	Battery	-
16	Noise Level	80 dBA limit
17	Total Mass/ Total Mass on Head	-
18	2164-10 Filter Classification	HE*

“-“=Equivalent

“**“= NIOSH approved HE protection filters can be used for protection against particulate aerosols containing oil. However, for reliable operation and desirable useful run time, Bio-Medical Devices Intl does not recommend Filter Cartridge use against particulate aerosols containing oil.

2500-30TSC/ 2500-37TSC/ 2500-36TSC Battery Specification		
IPXO Ordinary Equipment Duty Cycle: Continuous Operation.		
#	PROPERTY	SPECIFICATIONS
1	Minimum Continuous Operating Time: 2500-36TSC	4 Hrs. (Typical 4-10 hr./Charge)
2	Minimum Continuous Operating Time: 2500-37TSC	6 Hrs. (Typical 6-15 hr./Charge)
3	Charge Input	16.8V; 1A
4	Electrical Output: 2500-36TSC	14.8V; 2.25Ah
5	Electrical Output: 2500-37TSC	14.8V; 3.35Ah
6	Electrical Output: 2500-30TSC	14.8V; 4.50Ah
2600-01 Charger Specification		
#	PROPERTY	SPECIFICATIONS
1	Complete Charge for 2500-36TSC, 2500-37TSC, or 2500-30TSC	4-6 Hours for a Fully Drained Battery
2	Electrical Output	Up to 16.8V; Up to 0.9A
3	Electrical Input	100-240 VAC; 50-60Hz; 0.3A

MAX  **AIR**®

SYNTECH INTL

17171 Daimler Street • Irvine, CA 92614 • 800-443-3842 • www.syntech-intl.com